

Product catalogue 2024  
Rev.01

**MEBERIT<sup>®</sup>**



Products, technologies and services  
for first aid and medical emergency

[www.meber.it](http://www.meber.it)

# INDEX

| Category                    | Page |
|-----------------------------|------|
| Stretchers                  | 14   |
| Ambulance Cots and Trolleys | 34   |
| Carry and Stair Chairs      | 70   |
| Accessories                 | 88   |
| Immobilization              | 108  |
| Diagnostics                 | 134  |
| Resuscitation               | 148  |
| First Aid                   | 160  |
| Fastening Systems           | 182  |
| Restraint Systems           | 188  |
| Supports                    | 192  |
| Veterinary                  | 199  |

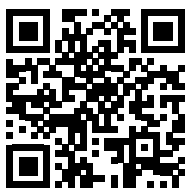

**Discover MeBer products on-line**  
Shoot the QR code with your tablet or smartphone to land on the dedicated page on the website. You might be required to install a free application to navigate.

Alternatively, go to:  
<https://www.meber.it/en/prodotti.aspx>



# MEBER

PRODUCTS,  
TECHNOLOGY AND  
SERVICE FOR **FIRST  
RESPONSE** AND  
**EMERGENCY AID**

**AT YOUR SIDE IN EVERY STEP OF  
THE WAY**

---

Founded in 1987 in Parma, MeBer has grown to become a leading player in the field of design and production of medical equipment for emergency aid, rescue and first response. Ever since its origin MeBer stood out for its company culture, based on passion, professionalism, quality and innovation: essential characteristics to become a loyal partner for all operators.

**MEBERTH<sup>®</sup>**

IN CASE OF EMERGENCY



IN CASE OF EMERGENCY



## MISSION AND CORPORATE CULTURE

In MeBer, planning and design are an out-and-out mission for all staff members: helping and supporting the rescue operators in order to achieve excellent performances, in complete safety, is our true mission.

## MEBER A RELIABLE PARTNER, WORLDWIDE

MeBer counts on a vast sales network on the domestic sector as well as a widespread distribution network made up of distributors and re-sellers in more than 60 countries.

MeBer is an ever-present member of the most important Trade Fairs such as REAS (Montichiari-Italy), Medica (Düsseldorf – Germany), Arab Health (Dubai – Arab Emirates), Rettmobil (Fulda – Germany), FIME (Miami – USA) and actively participates in a variety of local events and congresses.

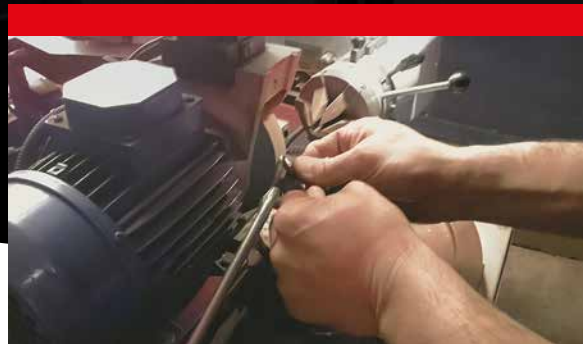

## INNOVATION, TECHNOLOGY AND CUSTOMER CARE

---

MeBer is a young and dynamic company, strongly oriented towards the needs of the market and a constant improvement of the quality of its products. Thanks to the efficiency of a qualified team and by means of a dedicated communication with emergency operators, MeBer invests a major portion of its resources in the research and development of new advanced technological devices, certified according to the most recent European Standards (UNI EN 1865 – UNI EN 1789). The research of innovative materials as well as the application of state-of-the-art mechanisms have characterized MeBer's range over the years.

## TOTAL QUALITY MANAGEMENT

---

MeBer has a whole department dedicated to the implementation of the quality management system of its products, following every phase of their life-cycle, starting from their design up to the after-sales service.

This led the company to achieve the European Standards UNI EN ISO 9001:2015 and UNI CEI EN ISO 13485:2016.

Every step of the production, from the design phase up to the development and manufacturing, are carried out internally with the aid of state-of-the-art machines and equipment as every phase undergoes strict quality monitoring.

The rigid quality process continues up to the after sales service, namely customer service and technical assistance (ordinary and extra-ordinary) that the company oversees to optimize performance and reliability of the products.

# THE BEST PARTNER...

**PRODUCTS,  
TECHNOLOGIES AND  
SERVICES FOR FIRST  
AID AND MEDICAL  
EMERGENCY**



## MEBER ON-SITE (Italy) Directly at your premises

One of our technicians will visit your premises and carry out all necessary activities which might include:

- ✓ Ordinary maintenance
- ✓ Extra-ordinary maintenance
- ✓ Restoration
- ✓ Updates (if applicable)

## MEBER SERVICE NETWORK (Italy and World) Through authorized Service Centres

The products are shipped directly to Me.Ber or to an authorized Service Centre of your choice. We carry out all necessary tests and maintenance. The devices are then shipped back to you in the shortest possible time.

# DEDICATED TO MEDICAL EMERGENCY OPERATORS



## MEBER, THE ONLY PARTNER THAT CARES ABOUT YOUR DEVICES AND KEEPS THEM EFFICIENT

---

A professional after sales service carried out by the manufacturer is a crucial support for any structure: it is a requirement in most Italian regions if the brand wishes to obtain accreditation. Furthermore, the law states that it is compulsory for every structure to ensure the correct efficiency of their own devices. Proper maintenance is a fundamental aspect of the medical equipment sector, as it ensures the safety of rescue operators and patients. It also constitutes legal protection to the Coordinators and Administrators in the event of an accident.



# MEBER CUSTOMER CARE

**MeBer's customer care comprises all of the exclusive after-sales services offered by the company.**

The service is available either on-site (i.e. at the customer's premises), at MeBer's headquarters or at one of the authorized service centres, depending on the type of maintenance required and on the geographical area.





# QUALITY

## 10G PROOF PRODUCTS



### MEBER: SHOCK-PROOF EMERGENCY!

MeBer has put an emphasis on the safety and reliability of the products ever since the beginning of its journey, pioneering the birth of European standards and regulations as well as anticipating the needs of the emergency sector as we know it. The philosophy behind the company's path so far is driven by the hard-rooted conviction that a safe and regulated medical device shall safeguard both patients and operators, reducing the risk of accidents and consequently protecting the operators from moral and legal responsibilities. MeBer has performed 10G tests since 2001: today, the vast majority of the products in the range are certified!

### EUROPEAN REGULATIONS FOR A SAFE TRANSPORT

The European Standards that regulate the transport of stretchers and rescue devices on the ambulances are EN 1865 and EN 1789, which integrates and completes the former. European Standard EN 1865, known as UNI EN 1865 in Italy, has been in force since 1999 and dictates rigid technical standards, configurations, maximum height and length, maximum weight, minimum load, etc. to ensure a safe transport of the medical devices during transport. UNI EN 1789 completed the regulations, imposing the requirement of 10G PROOF testing of the medical devices and relative fastening and locking systems: the devices transported by an ambulance must endure, in the event of an accident, an acceleration equal to 10 times the weight of the device. Patient's transport devices must also ensure that they can hold a 75 KG individual (average body weight). Specifically, the regulation requires that the afore-mentioned force is applied in all directions and that no damage is sustained by either patient or operators on board of the vehicle.

# WHAT'S NEW ON THIS CATALOGUE



## NEW PRODUCTS AND UPDATES

|  |  |  |   |                                 |                                 |  |
|--|--|--|---|---------------------------------|---------------------------------|--|
| <p>p. 44</p> <p>Art. 7075/4RG PROOF<br/>7077/4RG PROOF</p> | <p>p. 46</p> <p>Art. 7095/4RG PROOF<br/>7097/4RG PROOF</p> | <p>p. 48</p> <p>Art. 7092 PROOF<br/>7094 PROOF</p> | <p>p. 82</p> <p>Art. 12182</p>                      | <p>p. 82</p> <p>Art. 12180</p>  | <p>p. 86</p> <p>Art. 668</p>    | <p>p. 98</p> <p>Art. 12084 - 12086 - 12088<br/>12170 - 12172</p> |
| <p>p. 99</p> <p>Art. 12200 - 12202 -<br/>12204</p>         | <p>p. 105</p> <p>Art. 707</p>                              | <p>p. 107</p> <p>Art. 12084-001</p>                | <p>p. 121</p> <p>Art. 9114</p>                      | <p>p. 144</p> <p>Art. 8377</p>  | <p>p. 145</p> <p>Art. 8540</p>  | <p>p. 158</p> <p>Art. 2411 - 2413 -<br/>2414 - 2415</p>          |
| <p>p. 160</p> <p>Art. 1233 - 1234</p>                      | <p>p. 166</p> <p>Art. 1319</p>                             | <p>p. 166</p> <p>Art. 1318</p>                     | <p>p. 168</p> <p>Art. 1322</p>                      | <p>p. 178</p> <p>Art. 714</p>   | <p>p. 179</p> <p>Art. 11162</p> | <p>p. 183</p> <p>Art. 1982</p>                                   |
| <p>p. 189</p> <p>Art. 977</p>                              | <p>p. 197</p> <p>Art. 600/N</p>                            | <p>p. 197</p> <p>Art. 601/N</p>                    | <p>p. 202</p> <p>Art. 19170 - 12180 -<br/>12182</p> | <p>p. 204</p> <p>Art. 19115</p> | <p>p. 204</p> <p>Art. 19123</p> | <p>p. 204</p> <p>Art. 787L</p>                                   |

## AN OVERVIEW OF THE CATALOGUE...

### APPLICATION SYMBOLS

To understand if a product suits your needs, at a glance!



Pediatric

**NEONATAL AND/OR PEDIATRIC  
DEVICE**



Bariatric

**PRODUCT FOR BARIATRIC  
PATIENTS**



Cardio

**DEVICE FOR THE TREATMENT OF  
CARDIOLOGICAL EMERGENCIES**



Trauma

**DEVICE FOR THE TREATMENT OF  
TRAUMATIC EMERGENCIES**



Alpine

**PRODUCT FIT FOR ALPINE  
RESCUE**

The new products are easily spotted! Search for the "New Product" Logo to easily identify what's new!

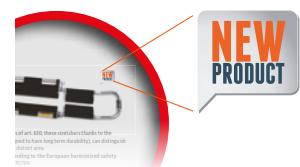

# STRETCHERS





A stretcher is often the first rescue and transfer device of a patient. Ranging from the traditional and ultra-tested scoop stretchers in the 630 SERIES to the revolutionary ERGON, Me.Ber's stretchers are the archetype of reliability at an international level. The constant exchange of information with the rescue operators is the key of the

success of these products. Thanks to the choice of materials, their simplicity of use and ergonomics, they represent a benchmark in the medical equipment field. Me.Ber offers a very rich line of stretchers for any operating environment, ranging from adults to pediatric and bariatric patients.

Discover MeBer products on-line. Shoot the QR code with your tablet or smartphone to land on the dedicated page on the website. You might be required to install a free application to navigate.

Alternatively, go to:  
<https://www.meber.it/en/products/stretchers.aspx>



# STRETCHERS

| Article Code | Type   |
|--------------|--|
| 16150/V      | ERGON variable geometry comfort stretcher                                      |
| 16150/G      | ERGON variable geometry comfort stretcher                                      |
| 16160/V      | ERGON Junior variable geometry comfort stretcher                               |
| 16160/G      | ERGON Junior variable geometry comfort stretcher                               |
| 631          | MAXIMA grey anodized anti trauma scoop stretcher with head/trunk in 1 pc       |
| 631/G        | MAXIMA yellow painted anti trauma scoop stretcher with head/trunk in one piece |
| 630          | MAXIMA grey painted anti trauma scoop stretcher                                |
| 630/G        | MAXIMA yellow painted anti trauma scoop stretcher                              |
| 630/V        | MAXIMA green painted anti trauma scoop stretcher                               |
| 630/B        | MAXIMA blue painted anti trauma scoop stretcher                                |
| 630/A        | MAXIMA orange painted anti trauma scoop stretcher                              |
| 630/N        | MAXIMA black painted anti trauma scoop stretcher                               |
| 633          | AXIM   |
| 6200         | Pediatric anti trauma scoop stretcher  |
| 638          | Folding rescue stretcher with adjustable back rest                             |
| 640          | Folding rescue stretcher   |
| 643          | Duo fold rescue stretcher  |
| 646          | Folding rescue stretcher   |
| 644          | Stiff fixed stretcher for stowage  |
| 644/S        | Stiff fixed stretcher for stowage with back rest                               |
| 660          | 4 pieces folding stretcher with telescopic handles                             |
| 1550         | Barella militare pieghevole con telo verde                                     |
| 1510 PROOF   | Stiff stretcher with nylon cover   |
| 1515 PROOF   | Stiff stretcher with rigid cover   |
| 13010        | ICARUS multi level stretcher with side protection                              |
| 13012        | ICARUS multi level stretcher with stainless steel tank                         |
| 13018        | CRONOS multi level stretcher with back rest and Trendelenburg                  |
| 16100        | TOBOGA stretcher with belts and foot support                                   |
| 16102        | TOBOGA detachable stretcher with belts and foot support                        |

Materials: ◆ Stainless steel ◆ Anodized aluminium ◆ Painted Aluminium ◆ ABS

## COMPARATION CHART

| Colour | 10G Certification | Material        | Height   | Width    | Min length | Max length | Folded length | Thickness folded | Weight  | Load   |
|--------|-------------------|-----------------|----------|----------|------------|------------|---------------|------------------|---------|--------|
|        | ✓                 | HC <sup>3</sup> | 7,5 cm   | 43 cm    | 165 cm     | 201 cm     | 120 cm        | 9 cm             | 10,5 kg | 170 kg |
|        | ✓                 | HC <sup>3</sup> | 7,5 cm   | 43 cm    | 165 cm     | 201 cm     | 120 cm        | 9 cm             | 10,5 kg | 170 kg |
|        |                   | HC <sup>3</sup> | 7,5 cm   | 43 cm    | 129 cm     | 153 cm     | 85 cm         | 9 cm             | 8,4 kg  | 170 kg |
|        |                   | HC <sup>3</sup> | 7,5 cm   | 43 cm    | 129 cm     | 153 cm     | 85 cm         | 9 cm             | 8,4 kg  | 170 kg |
|        | ✓                 |                 | 7 cm     | 42 cm    | 167 cm     | 202 cm     | 120 cm        | 9 cm             | 9,5 kg  | 170 kg |
|        | ✓                 |                 | 7 cm     | 42 cm    | 167 cm     | 202 cm     | 120 cm        | 9 cm             | 9,5 kg  | 170 kg |
|        | ✓                 |                 | 7 cm     | 42 cm    | 167 cm     | 202 cm     | 120 cm        | 9 cm             | 10 kg   | 170 kg |
|        | ✓                 |                 | 7 cm     | 42 cm    | 167 cm     | 202 cm     | 120 cm        | 9 cm             | 10 kg   | 170 kg |
|        | ✓                 |                 | 7 cm     | 42 cm    | 167 cm     | 202 cm     | 120 cm        | 9 cm             | 10 kg   | 170 kg |
|        | ✓                 |                 | 7 cm     | 42 cm    | 167 cm     | 202 cm     | 120 cm        | 9 cm             | 10 kg   | 170 kg |
|        | ✓                 |                 | 7 cm     | 42 cm    | 167 cm     | 202 cm     | 120 cm        | 9 cm             | 10 kg   | 170 kg |
|        | ✓                 |                 | 7 cm     | 42 cm    | 167 cm     | 202 cm     | 120 cm        | 9 cm             | 10 kg   | 170 kg |
|        | ✓                 |                 | 6 cm     | 42 cm    | 168cm      | 211 cm     | 120 cm        | 9 cm             | 8,3 kg  | 170 kg |
|        |                   |                 | 7 cm     | 42 cm    | 130 cm     | -          | -             | -                | 7,8 kg  | 170 kg |
|        |                   |                 | 14 cm    | 49 cm    | 187 cm     | -          | 98 cm         | 17 cm            | 9,2 kg  | 170kg  |
|        |                   |                 | 14 cm    | 48 cm    | 186 cm     | -          | 92 cm         | 17 cm            | 6,5 kg  | 170 kg |
|        |                   |                 | 12 cm    | 49/12 cm | 195 cm     | -          | 97 cm         | 17 cm            | 5 kg    | 170 kg |
|        |                   |                 | 14 cm    | 50 cm    | 201 cm     | -          | 101 cm        | 17 cm            | 6,2 kg  | 170 kg |
|        |                   |                 | 17 cm    | 48 cm    | 186 cm     | -          | -             | -                | 4,9 kg  | 170 kg |
|        |                   |                 | 17 cm    | 48 cm    | 186 cm     | -          | -             | -                | 5,9 kg  | 170 kg |
|        |                   |                 | 18 cm    | 57/11 cm | 192 cm     | 216 cm     | 94 cm         | 21 cm            | 9,3 kg  | 170 kg |
|        |                   |                 | 17 cm    | 58/11 cm | 198 cm     | 231 cm     | 198 cm        | -                | 9 kg    | 170 kg |
|        | ✓                 |                 | 16 cm    | 57 cm    | 196 cm     | 233 cm     | -             | -                | 15 kg   | 170 kg |
|        | ✓                 |                 | 16 cm    | 57 cm    | 196 cm     | 233 cm     | -             | -                | 20,8 kg | 170 kg |
|        |                   |                 | 42/88 cm | 62 cm    | 191 cm     | -          | -             | -                | 29,5 kg | 170 kg |
|        |                   |                 | 51/96 cm | 62 cm    | 198 cm     | -          | -             | -                | 39 kg   | 170 kg |
|        |                   |                 | 48/86 cm | 59 cm    | 198 cm     | -          | -             | -                | 37 kg   | 170 kg |
|        |                   |                 | 17 cm    | 61 cm    | 216 cm     | -          | -             | -                | 15 kg   | 300 kg |
|        |                   |                 | 17 cm    | 61 cm    | 216 cm     | -          | 108/114 cm    | -                | 15 kg   | 300 kg |



# ERGON

VARIABLE GEOMETRY COMFORT STRETCHER



Art.  
16150/G



Alpine



Pediatric



Trauma

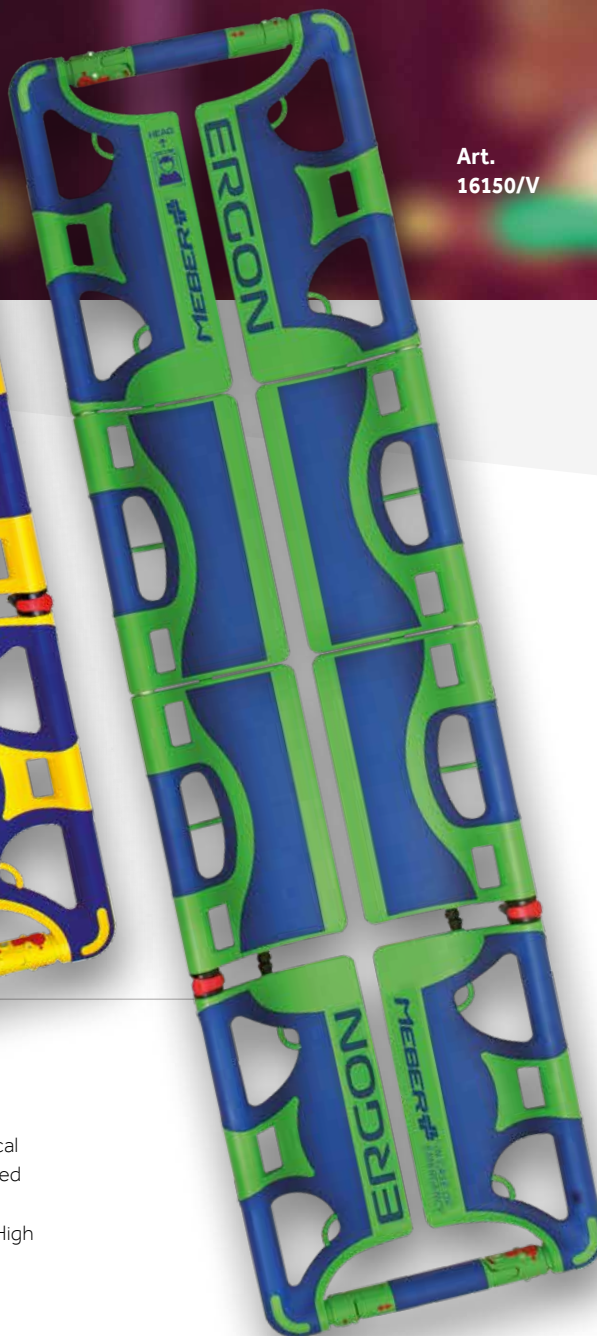

Art.  
16150/V





Art. 16150/V / Art. 16150/G

## ERGON

### Variable geometry comfort stretcher

ERGON was designed by rescue operators and experts of the medical emergency sector to offer outstanding performances, never achieved before. This stretcher ensures maximum comfort, especially in bed sore areas, thanks to a special material (the exclusive MeBer HC3 – High Comfort Composite Cell) consisting in a soft material moulded on a high resistance plastic polymer.

## Technical data

| Art.    | Colour  | Material        | Height | Width | Min length | Max length | Folded length | Thickness folded | Weight  | Load   |
|---------|---|-----------------|--------|-------|------------|------------|---------------|------------------|---------|--------|
| 16150/V |  | HC <sup>3</sup> | 7,5 cm | 43 cm | 165 cm     | 201 cm     | 120 cm        | 9 cm             | 10,5 kg | 170 kg |
| 16150/G |  | HC <sup>3</sup> | 7,5 cm | 43 cm | 165 cm     | 201 cm     | 120 cm        | 9 cm             | 10,5 kg | 170 kg |

# # flexilock

## OPERATING PROCEDURES



A technological revolution: the new jointed locking system Flexilock allows to separate the stretcher in two halves and facilitates rescue operations even in extreme conditions.

Beside fitting all standard rescue techniques, ERGON allows to easily perform rescue operations in extreme environments and when the patient is in critical conditions.



## # HC<sup>3</sup> High Comfort Composite Cell

Hard plastic reinforcements were added to the corners to avoid damaging of the soft material during rescue operations or storage on the vehicles. These reinforcements also grant better sliding characteristics inside of the storage compartments. All indications on how to operate the Flexilock locking device are highlighted with a high contrast colour, in order to make them visible in dark and low-visibility situations.



Beside patient's comfort, ERGON is designed to assist the rescue operators thanks to unique solutions.

The handles are upholstered in HC<sup>3</sup> and present a 20° inclination, thus allowing a better grip. Dedicated eyelets and supports were integrated for the fastening of straps and carabiners. When split, the distance between the two halves measures 25 mm: this ensures excellent support to the spinal column, in contrast with regular scoop stretchers which present an 80 mm distance. The

shape of the blade is also larger than usual and is easily placed between the patient and the ground. The employment of HC<sup>3</sup> material, besides conferring excellent structural stability, ensures great thermal insulation. This feature prevents hypothermia and allows for a longer stay of the patient on the ERGON stretcher, thanks to its design

**Device certified according to the European harmonized safety standards UNI EN 1865 – UNI EN 1789.**

# ERGON

## ACCESSORIES

**Art.  
9150**



**X-LOCK Ergonomic head immobilizer**

One-piece head immobilizer with integrated head strap, for a fast head immobilization directly on the stretcher. Made with laminated polyesters and bi-density polyurethane foams.

**Art.  
9150-001**



Blue carrying case for X-LOCK ergonomic head immobilizer

**Art.  
16150-001**



Winch bag for transfers  
cm 124x32x16

**Art.  
Art. 16150-002**



Storage bag cm  
122x47x8

**Art.  
572**

Blue strap in  
2 pieces with  
metallic buckle  
(155 cm length)



**Art.  
574**

Blue bag  
with 3  
belts art.  
572

**Art.  
959**

Wall mount  
system



Accessories

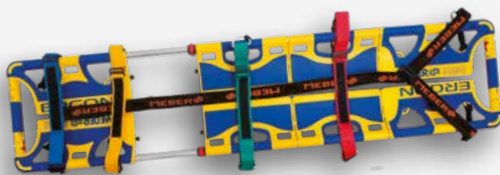

**Art.  
9156**

**X-FIX Restraint system with straps and carabiners**

Standard restraint straps with carabiners: an innovative system designed to ease and accelerate any rescue operation, ensuring high comfort and providing stability to the spinal column.

**Art.  
584**

Black bag with 3 orange straps in 2  
pieces and quick-release plastic buckle



Factory-equipped  
with:



# ERGON JUNIOR

PEDIATRIC VARIABLE  
GEOMETRY  
COMFORT  
STRETCHER



Pediatric

Art.  
16160/G

Art.  
16160/V

Art. 16160/V / Art. 16160/G

## ERGON JUNIOR

Pediatric variable geometry comfort stretcher

ERGON share its advanced technology with the junior model. All benefits and main features of the adult stretcher are preserved in its Junior version. The Flexilock locking system was moved from the centre to the side, in order to allow operations without invading the head-space. The large blade allows for maximum comfort even to pediatric patients.

### Technical data

| Art.    | Colour | Material        | Height | Width | Min length | Max length | Folded length | Thickness folded | Weight | Load   |
|---------|--------|-----------------|--------|-------|------------|------------|---------------|------------------|--------|--------|
| 16160/V |        | HC <sup>3</sup> | 7,5 cm | 43 cm | 129 cm     | 153 cm     | 85 cm         | 9 cm             | 8,4 kg | 170 kg |
| 16160/G |        | HC <sup>3</sup> | 7,5 cm | 43 cm | 129 cm     | 153 cm     | 85 cm         | 9 cm             | 8,4 kg | 170 kg |

# MAXIMA

ANTI TRAUMA SCOOP STRETCHER



Separate torso/head sections

United torso / head sections

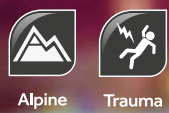

Art. 630

## MAXIMA

Grey anodized anti trauma scoop stretcher

Thanks to its features, this stretcher can be placed under the patient with ease, without lifting the body. Built with carefully designed materials, MAXIMA ensures solidity, reliability and durability.

**Device certified according to the European harmonized safety standards UNI EN 1865 – UNI EN 1789.**

Art. 6200

## MAXIMA

Pediatric anti trauma scoop stretcher



Pediatric

Fit for pediatric rescue, reduced size.

Art. 631





## MAXIMA

Grey anodized anti trauma scoop stretcher with head/torso in 1 piece

Scoop stretcher: the difference between this model and Art. 630 is that the head and torso areas are united in 1 piece. They share the same size.

**Device certified according to the European harmonized safety standards UNI EN 1865 – UNI EN 1789.**

- ✓ Efficient splitting system with locking device
- ✓ Adjustable length with automatic locking device
- ✓ Bag with 3 straps (quick release) for the immobilization of the patient (Art. 603 / MEB)
- ✓ Easily arranged inside the ambulance when folded
- ✓ Built with light and sturdy aluminium
- ✓ Carrying case available on request (Art. 630/CS).

Art. 630/B  Art. 630/V   
 Art. 630/A  Art. 630/G 



Art. 630/N

## MAXIMA

Painted anti trauma scoop stretcher

Keeping the very same features of art. 630, thanks to a special paint (designed for optimal durability) this stretcher can be used to differentiate operators or a specific area of operation. **Device certified according to the European harmonized safety standards UNI EN 1865 – UNI EN 1789.**



Art. 631/G

## MAXIMA

Yellow painted anti trauma scoop stretcher with head/torso in one piece

Keeping the same features of Art. 631, this stretcher helps differentiating operators or a specific area of operation thanks to its special yellow paint (designed for optimal durability). **Device certified according to the European harmonized safety standards UNI EN 1865 – UNI EN 1789**

Art. 633

## AXIM

Grey anodized anti trauma scoop stretcher with head/trunk in one piece



Thanks to its features the scoop stretcher has an important role in first aid as it can be put under the patient without removing him. The shape of the stretcher also enables the perfect immobilization of the patient during his transport. Once folded easy arrangement inside the ambulance. Supplied with a bag with three belts (2 pieces belts with plastic buckle). **Device certified according to the European harmonized safety standards UNI EN 1865 – UNI EN 1789**

### Accessories

Art. 630/CS

Carrying case for scoop stretchers



Art. 624

DOUBLE Head immobilizer for scoop stretchers



### Fastening Systems

Art. 614







Certified horizontal fastening system for scoop stretchers



Art. 616  
Art. 616/A

Certified vertical fastening system for scoop stretchers



| Art.                                      | Colour  | Material           | Height | Width | Min length | Max length | Folded length | Thickness folded | Weight | Load   |
|---|---|--------------------|--------|-------|------------|------------|---------------|------------------|--------|--------|
| 630                                       |  | Anodized aluminium | 7 cm   | 42 cm | 167 cm     | 202 cm     | 120 cm        | 9 cm             | 10 kg  | 170 kg |
| 631                                       |  | Anodized aluminium | 7 cm   | 42 cm | 167 cm     | 202 cm     | 120 cm        | 9 cm             | 9,5 kg | 170 kg |
| 631/G                                     |  | Painted Aluminium  | 7 cm   | 42 cm | 167 cm     | 202 cm     | 120 cm        | 9 cm             | 9,5 kg | 170 kg |
| 630/G<br>630/V<br>630/B<br>630/A<br>630/N |  | Painted Aluminium  | 7 cm   | 42 cm | 167 cm     | 202 cm     | 120 cm        | 9 cm             | 10 kg  | 170 kg |
| 633                                       |  | Anodized aluminium | 6 cm   | 42 cm | 168cm      | 211 cm     | 120 cm        | 9 cm             | 8,3 kg | 170 kg |
| 6200                                      |  | Anodized aluminium | 7 cm   | 42 cm | 130 cm     | -          | -             | -                | 7,8 kg | 170 kg |

# RESCUE STRETCHERS

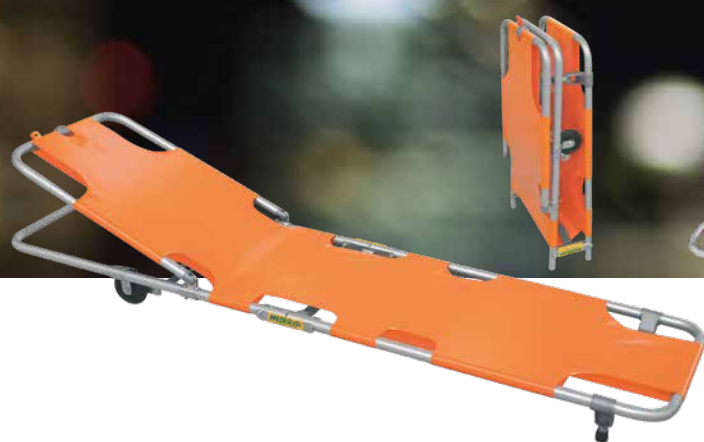

Art. 638

## Collapsible rescue stretcher

With adjustable backrest

Excellent as a secondary stretcher inside of an ambulance. It is supplied with a bag containing 2 straps (Art. 604 / MEB).



Art. 640

## Collapsible rescue stretcher

Suitable as a secondary stretcher inside of an ambulance. No backrest. It is supplied with a bag containing 2 straps for patient immobilization (Art. 604/MEB).

Fastening System

Art. 964



Front fastening system for rescue stretcher

Art. 950/4



Rear fastening system

Supplied with:

Art. 604/MEB

Orange bag with 2 straps 605 / MEB



| Art. | Colour and Material   | Height | Height | Min length | Folded length | Thickness folded | Weight | Load   |
|------|---|--------|--------|------------|---------------|------------------|--------|--------|
| 638  |  | 14 cm  | 49 cm  | 187 cm     | 98 cm         | 17 cm            | 9,2 kg | 170 kg |
| 640  | Anodized aluminium  | 14 cm  | 48 cm  | 186 cm     | 92 cm         | 17 cm            | 6,5 kg | 170 kg |



Art. 646

## Collapsible rescue stretcher

Foldable in 2 pieces

Designed for the transport also of heavy patients, this stretcher can be folded in two pieces.



The canvas is built in fire-resistant, impermeable, tear-resistant PVC-coated nylon. Fixed handles. Straps are not included (see "Restraint systems" Art. 604/MEB).

Art. 643

## Collapsible rescue stretcher

Foldable in 4 pieces

Built in tubular anodized aluminium, canvas in fire-resistant, impermeable, tear-resistant PVC-coated nylon. Fixed handles. Ideal for storage inside of any emergency vehicle. Straps are not included (see "Restraint systems" Art. 604/MEB).

| Art. | Colour  | Material           | Height | Width    | Max length | Folded length | Thickness folded | Weight | Load   |
|------|---|--------------------|--------|----------|------------|---------------|------------------|--------|--------|
| 643  |  | Anodized aluminium | 12 cm  | 49/12 cm | 195 cm     | 97 cm         | 17 cm            | 5 kg   | 170 kg |
| 646  |  | Anodized aluminium | 14 cm  | 50 cm    | 201 cm     | 101 cm        | 17 cm            | 6,2 kg | 170 kg |



# RESCUE STRETCHERS

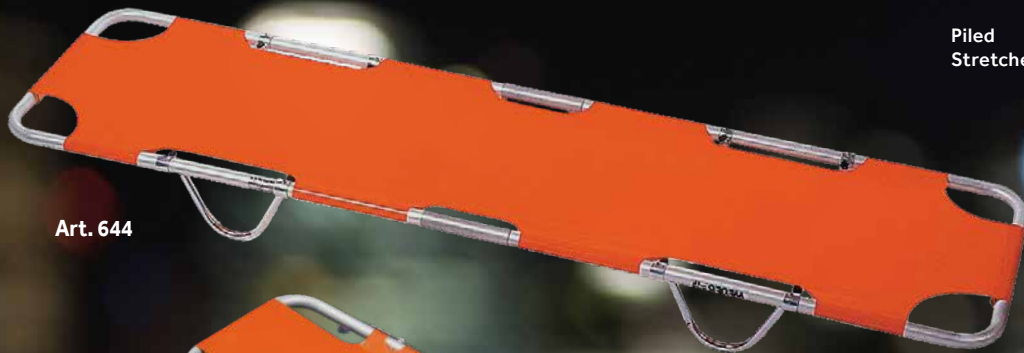

Art. 644

Piled  
Stretchers

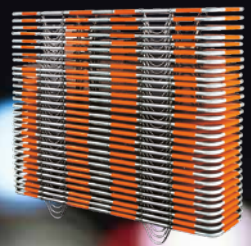

Art. 644/S

Art. 644

## Stiff fixed stretcher

Suited for storage

Fixed rigid stretcher for storage, easily piled on top of same-type stretchers for storage optimization. Supplied with 2 quick-release straps for patient immobilization (Art. 604/MEB).

- ✓ Light and handy
- ✓ Canvas in orange nylon, fire proof, impermeable, tear-resistant and easy to clean
- ✓ Sturdy aluminium frame
- ✓ Non-foldable

Art. 644/S

## Stiff fixed stretcher

Suited for storage, with backrest

Fixed rigid stretcher for storage, featuring a 3 position adjustable backrest. Supplied with 2 quick-release straps for patient immobilization (Art. 604/MEB)

| Art.  | Colour | Material           | Height | Width | Min length | Weight | Load   |
|-------|--------|--------------------|--------|-------|------------|--------|--------|
| 644   | ■      | Anodized aluminium | 17 cm  | 48 cm | 186 cm     | 4,9 kg | 170 kg |
| 644/S | ■      | Anodized aluminium | 17 cm  | 48 cm | 186 cm     | 5,9 kg | 170 kg |



Art. 660



Stretcher foldable in 4 pieces

Art. 660

## Collapsible stretcher

Foldable in 4 pieces, telescopic handles

This 4 pieces foldable stretcher is the most complete and versatile in the range. The sturdy tubular aluminium frame makes it light and robust. The stretcher features 4 telescopic handles that allow for a larger support surface.

The canvas is in fire-resistant, impermeable, tear resistant, easily cleanable grey nylon.

Supplied with 2 quick-release straps for patient immobilization (Art. 605/Nmeb).

Art. 660/CS



Carrying case for collapsible stretcher (foldable in 4 pieces) with telescopic handles.

Accessories



Art. 605/Nmeb



2 single-piece strap belts with plastic buckle and MeBer band

Supplied with



| Art. | Colour | Material           | Height | Width    | Min length | Max length | Folded length | Thickness folded | Weight | Load   |
|------|--------|--------------------|--------|----------|------------|------------|---------------|------------------|--------|--------|
| 660  | ■      | Anodized aluminium | 18 cm  | 57/11 cm | 192 cm     | 216 cm     | 94 cm         | 21 cm            | 9,3 kg | 170 kg |

# RESCUE STRETCHERS

Art. 1550



Folded  
stretcher

Art. 1550

## Military Stretcher

Collapsible stretcher with green canvas

Width-collapsible stretcher built in tubular aluminium and green fireproof military canvas. It features telescopic handles and strap belts for patient immobilization. Ideal for military applications.

| Art.       | Colour | Material           | Height | Width    | Min length | Max length | Folded length | Weight  | Load   |
|------------|--------|--------------------|--------|----------|------------|------------|---------------|---------|--------|
| 1550       | ■      | Anodized aluminium | 17 cm  | 58/11 cm | 198 cm     | 231 cm     | 198 cm        | 9 kg    | 170 kg |
| 1510 PROOF | ■      | Anodized aluminium | 16 cm  | 57 cm    | 196 cm     | 233 cm     | -             | 15 kg   | 170 kg |
| 1515 PROOF | ■      | Anodized aluminium | 16 cm  | 57 cm    | 196 cm     | 233 cm     | -             | 20,8 kg | 170 kg |

# FIXED STRETCHERS

FOR AMBULANCE  
TROLLEYS



**Art.  
7060/4RG +  
1510 PROOF**

Supplied with straps only in combination with a trolley: 2 pieces of art. 608-A/MEB or 608-N/MEB, 1 piece of art. 612/AN-2/MEB or 612/N-2/MEB



**Art.  
7060/4RG +  
1515 PROOF**



**Art. 1510 PROOF**

## Fixed stretcher with Nylon cover

Fixed stretcher built in anodized aluminium, canvas in fire-resistant and easily cleanable nylon. This model is suitable for our ambulance trolleys (TITANUS) or as a hand-carried stretcher.

**Device certified according to the European harmonized safety standards UNI EN 1865 – UNI EN 1789.**

- ✓ 4 extractable and adjustable handles
- ✓ 4 wheels (100 mm Ø)
- ✓ Adjustable backrest
- ✓ Supplied with straps (Art. 604/MEB)
- ✓ Foldable side rails



**Art. 1515 PROOF**

## Fixed stretcher with rigid bed

Fixed stretcher built in anodized aluminium with painted rigid backrest and bed. Resistant and easy to clean. Trendelenburg and Fowler positions. Suitable for our ambulance trolleys (TITANUS) or as a hand-carried stretcher. **Device certified according to the European harmonized safety standards UNI EN 1865 – UNI EN 1789.**

- ✓ 4 extractable and adjustable handles
- ✓ 4 wheels (100 mm Ø)
- ✓ Adjustable backrest
- ✓ Supplied with: 1 piece of Art. 7014, 2 pieces of Art. 608-A/MEB or 608-N/MEB, 3 pieces of Art. 605C, 1 piece of Art. 612/AN-2/MEB or 612/N-2/MEB
- ✓ Foldable side rails

# ICARUS

MULTI-LEVEL STRETCHER  
WITH SIDE RAILS



Art. 13010



Art. 13012

## ICARUS

Multi-level stretcher with steel tank



Icarus +  
mattress  
(1880-001)  
and cushion  
(1880-002)



Reclined  
Icarus

**Accessories**

Art. 607/A-MEB



Orange straps in 2 pieces with plastic buckle

Art. 607/B



Blue straps in 2 pieces with plastic buckle

Art. 1880-001



Skai mattress for ICARUS

Art. 1880-002



Skai Cushion for ICARUS

Art. F1813



Cover for ICARUS

Art. 13010

## ICARUS

### Multi-level stretcher with side rails

Built in stainless steel, our ICARUS multi-level stretcher features 4 wheels (Ø 125 mm, two with brakes), side rails and foot rest. 4 gas springs ensure precise adjustment to any required height, for a professional and practical operation.

Available with ABS loading bed for optimal cleanliness and disinfection (Art. 13010) and steel tank (Art. 13012). Both mattress and cushion are made of a fire-resistant, waterproof and easily cleanable material.

### Technical data

| Art.  | Colour | Material        | Height   | Width | Length | Weight  | Load   |
|-------|--------|-----------------|----------|-------|--------|---------|--------|
| 13010 |        | Stainless steel | 42/88 cm | 62 cm | 191 cm | 29,5 kg | 170 kg |
| 13012 |        | Stainless steel | 51/96 cm | 62 cm | 198 cm | 39 kg   | 170 kg |

# CRONOS

MULTI-LEVEL STRETCHER WITH BACK REST AND TRENDELENBURG



Art. 13018



Cronos set in low position



Cronos from the side

## Accessories

Art. 602/MEB

Orange bag with 3 straps (plastic buckle)



Art. 7013/A



Art. 7013/N



Art. 13018

## CRONOS

### Multi-level stretcher with back rest and trendelenburg

CRONOS is built in electropolished stainless steel, with foldable bed and side rails. The backrest and Trendelenburg are easily adjustable by means of gas springs, enabling virtually infinite positions. The 4 gas springs positioned below the loading bed allow perfect alignment at any height. Lastly, 4 wheels (Ø 200mm), 2 rotating wheels with brakes and 2 fixed swivel wheels, making CRONOS a handy and versatile stretcher.

### Technical data

| Art.  | Colour | Material        | Height   | Width | Length | Weight | Load   |
|-------|--------|-----------------|----------|-------|--------|--------|--------|
| 13018 | ■      | Stainless steel | 48/86 cm | 59 cm | 198 cm | 37 kg  | 170 kg |

# TOBOGA

TOBOGA STRETCHERS WITH STRAPS AND FOOT REST



Alpine



Trauma

Art. 16100



Accessories



Art. 16100-005

Certified lifting sling for Toboga stretchers



Art. 16100-002

Flotation system for Toboga stretcher



Art. 16100

## TOBOGA

Stretcher with straps and foot rest.

Consisting of an ABS modified polymer in the outer shell, supported by a strong aluminium frame. 12 hand grips ensure a very easy handling of the stretcher. Chemical-, UV-, rust- and corrosion resistant. Robust brass grommets, positioned on the sides, enable lifting the stretcher by means of art. 16100-005. One layer of EVA foam ensures high comfort to the patient. Supplied with 4 straps and adjustable foot rest.

### Technical data

| Art.  | Colour | Material                   | Height | Width | Length | Folded length | Weight | Load   |
|-------|--------|----------------------------|--------|-------|--------|---------------|--------|--------|
| 16100 | ■      | Anodized aluminium and ABS | 17 cm  | 61 cm | 216 cm | -             | 15 kg  | 300 kg |
| 16102 | ■      | Anodized aluminium and ABS | 17 cm  | 61 cm | 216 cm | 108/114 cm    | 15 kg  | 300 kg |



Alpine



Trauma

Art. 16102



Art. 16100-005

Certified lifting sling for Toboga stretchers



Art. 16102-001

Carry bag for detachable Toboga stretcher  
Size: 121 x 64 x 24 cm



Art. 16102

## TOBOGA

**Detachable stretcher with straps and foot rest**

This stretcher shares the same features as art. 16100. This model is made up of two halves that enable easy storage and carrying. The two halves are kept together by strong aluminium rods locked together with steel pivots.



Toboga detached in two halves

Accessories





# AMBULANCE COTS & TROLLEYS



# TROLLEYS

Ambulance cots and trolleys are the emblem of emergency rescue and first aid. They play the most delicate role on an emergency vehicle and must ensure a safe transport in order to avoid the worsening of a patient's condition. Furthermore, they must also safeguard the rescuers. Many precautions must be taken into consideration to ensure that the rescuers stay injury-free:

ergonomics, weight reduction and many other measures that prevent back injuries. Besides, all "10G PROOF" models are certified to ensure resistance to 10G acceleration forces, which are applied to the device during its testing phase to prove that it doesn't deform nor detach in case of a road crash.

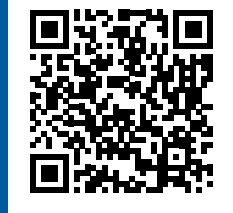

Discover MeBer products on-line. Shoot the QR code with your tablet or smartphone to land on the dedicated page on the website. You might be required to install a free application to navigate.

Alternatively, go to:  
<https://www.meber.it/en/products/self-loading-stretchers.aspx>

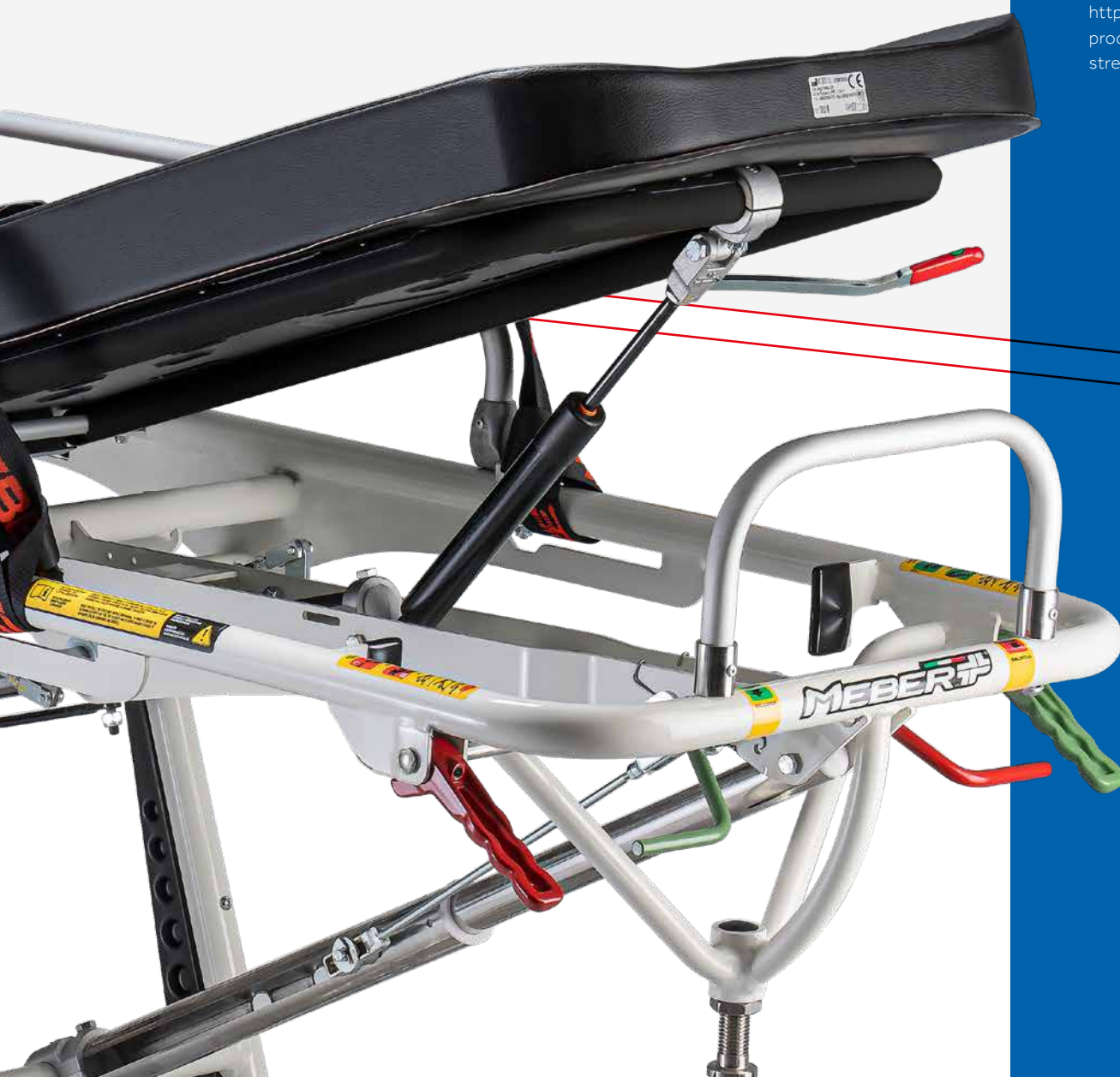

# AMBULANCE COTS & TROL

|                         | Item code                   | Name   | Type                                    | Colour | 10G certificate | Material | Adjustable height | Trendelenburg | Fowler | Intermediate height        |
|-------------------------|-----------------------------|--|---|--------|-----------------|----------|-------------------|---------------|--------|----------------------------|
| Self Loading Trolleys   | 7060 PROOF                  | TITANUS  | Low version                             | ■      | ✓               | ◆        | ✓                 |               |        | 61 cm                      |
|                         | 7062 PROOF                  |  | High version                            | ■      | ✓               | ◆        | ✓                 |               |        | 61 cm                      |
|                         | 7060/4RG PROOF              | TITANUS 4  | 4 rotating wheels, low version          | ■      | ✓               | ◆        | ✓                 |               |        | 61 cm                      |
|                         | 7062/4RG PROOF              |  | 4 ruote girevoli alta                   | ■      | ✓               | ◆        | ✓                 |               |        | 61 cm                      |
|                         | 7240/INC PROOF              | FROG INC   | Plus, for incubators                    | ■      | ✓               | ◆        |                   |               |        |                            |
|                         | 7260/INC PROOF              |  | CERTIFIED plus for incubators           | □      | ✓               | ◆        |                   |               |        |                            |
|                         | 910/GIN                     | WINNER GIN   | CERTIFIED Lite for incubators           | ■      |                 | ◆        |                   |               |        |                            |
|                         | 910/GIN PROOF               |  | For incubators                          | ■      | ✓               | ◆        |                   |               |        |                            |
|                         | 7034                        |  | Fixed trolley for incubator transport   | ■      |                 | ◆        |                   |               |        |                            |
|                         | 7112 PROOF                  | EVOX   | CERTIFIED Chair/Cot                     | ■      | ✓               | ◆        |                   |               |        |                            |
| Self Loading Stretchers | 7080/4RG PROOF              | MERCURY LITE 4   | 4 rotating wheels, low version          | ■      | ✓               | ◆        | ✓                 | ✓             |        | 72 cm                      |
|                         | 7082/4RG PROOF              |  | 4 rotating wheels, high version         | ■      | ✓               | ◆        | ✓                 | ✓             |        | 75 cm                      |
|                         | 7070 PROOF                  | MERCURY  | Low version                             | ■      | ✓               | ◆        | ✓                 | ✓             |        | 72 cm                      |
|                         | 7072 PROOF                  |  | High version                            | ■      | ✓               | ◆        | ✓                 | ✓             |        | 75 cm                      |
|                         | 7070/4RG PROOF              | MERCURY 4  | 4 rotating wheels, low version          | ■      | ✓               | ◆        | ✓                 | ✓             |        | 72 cm                      |
|                         | 7072/4RG PROOF              |  | 4 rotating wheels, high version         | ■      | ✓               | ◆        | ✓                 | ✓             |        | 75 cm                      |
|                         | 7075/4RG PROOF              | MERCURY 5  | 4 rotating wheels, low version          | ■      | ✓               | ◆        | ✓                 | ✓             |        | 95 - 87 - 79 - 68 - 37 cm  |
|                         | 7077/4RG PROOF              |  | 4 rotating wheels, high version         | ■      | ✓               | ◆        | ✓                 | ✓             |        | 101 - 91 - 82 - 70 - 39 cm |
|                         | 7095/4RG PROOF              | MERCURY 5 LITE   | 4 rotating wheels, low version          | ■      | ✓               | ◆        | ✓                 | ✓             |        | 95 - 87 - 79 - 68 - 37 cm  |
|                         | 7097/4RG PROOF              |  | 4 rotating wheels, high version         | ■      | ✓               | ◆        | ✓                 | ✓             |        | 101 - 91 - 82 - 70 - 39 cm |
|                         | 7092 PROOF                  | MERCURY EL   | Low version                             | ■      | ✓               | ◆        |                   | ✓             |        |                            |
|                         | 7094 PROOF                  |  | High version                            | ■      | ✓               | ◆        |                   | ✓             |        |                            |
|                         | 7300                        | MEBER-X  |   | ■      |                 | ◆        | ✓                 | ✓             | ✓      |                            |
|                         | 7210                        | FROG   | With Trendelenburg                      | ■      |                 | ◆        |                   | ✓             |        |                            |
|                         | 7210 PROOF                  |  | CERTIFIED with Trendelenburg            | ■      | ✓               | ◆        |                   | ✓             |        |                            |
|                         | 7240 PROOF                  | FROG PLUS  | Plus with Trendelenburg                 | ■      | ✓               | ◆        |                   | ✓             |        |                            |
|                         | 7260 PROOF                  | FROG LITE  | CERTIFIED Plus with Trendelenburg       | ■      | ✓               | ◆        |                   | ✓             |        |                            |
|                         | 910                         | WINNER   | CERTIFIED with Trendelenburg            | ■      |                 | ◆        |                   |               |        |                            |
|                         | 910 PROOF                   |  | CERTIFIED ambulance cot                 | ■      | ✓               | ◆        |                   |               |        |                            |
|                         | 914                         |  | Trendelenburg and Fowler                | ■      |                 | ◆        |                   | ✓             | ✓      |                            |
|                         | 914 PROOF                   |  | CERTIFIED with Trendelenburg and Fowler | ■      | ✓               | ◆        |                   | ✓             | ✓      |                            |
|                         | 7122/V                      | GECKO  | Entry-level cot, green                  | ■      |                 | ◆        |                   |               |        |                            |
| 7122/AZ                 | Entry-level cot, light-blue |  | ■                                       |        | ◆               |          |                   |               |        |                            |
| 7270 PROOF              | MBS                         | Ambulance cot for bariatric transport "MBS-01 MeBer Bariatric Stretcher" | ■                                       | ✓      | ◆               |          |                   |               |        |                            |

Materials: ◆ Stainless steel ◆ Painted steel ◆ Anodized Aluminium ◆ Painted Aluminium

## COMPARISON TABLE

# TROLLEYS

| Max height | Min Loading Height | Folded height | Folded height (with stretcher) | Width | Rear axle width | Length | Min length | Folded length | Chair position min length | Weight load capacity | Loading capacity |
|------------|--------------------|---------------|--------------------------------|-------|-----------------|--------|------------|---------------|---------------------------|----------------------|------------------|
| 84 cm      | 64 cm              | 60 cm         | 25 cm                          | 44 cm | 56 cm           | 197 cm |            |               |                           | 34,5 kg              | 220 kg           |
| 89 cm      | 72 cm              | 68 cm         | 25 cm                          | 44 cm | 56 cm           | 197 cm |            | 200 cm        |                           | 35 kg                | 220 kg           |
| 84 cm      | 64 cm              | 60 cm         | 25 cm                          | 44 cm | 56 cm           | 197 cm |            |               |                           | 36,5 kg              | 220 kg           |
| 89 cm      | 72 cm              | 68 cm         | 25 cm                          | 44 cm | 56 cm           | 197 cm |            | 200 cm        |                           | 37 kg                | 220 kg           |
| 82 cm      | 66 cm              | 60 cm         | 27 cm                          | 56 cm |                 | 195 cm | 166 cm     |               |                           | 38 kg                | 250 kg           |
| 83 cm      | 66 cm              | 60 cm         | 26 cm                          | 56 cm |                 | 196 cm | 167 cm     |               |                           | 27,5 kg              | 250 kg           |
| 80 cm      | 65 cm              | 45 cm         | 22 cm                          | 56 cm |                 | 194 cm | 162 cm     |               |                           | 28 kg                | 170 kg           |
| 80 cm      | 65 cm              | 62 cm         | 22 cm                          | 56 cm |                 | 194 cm | 155 cm     |               |                           | 31 kg                | 170 kg           |
| 74 cm      |                    |               |                                | 57 cm |                 | 90 cm  |            |               |                           | 30,5 kg              |                  |
| 80 cm      | 67 cm              |               | 27 cm                          | 60 cm |                 | 193 cm |            | 198 cm        | 123 cm                    | 44,5 kg              | 220 kg           |
| 95 cm      | 66 cm              | 64 cm         | 31 cm                          | 57 cm |                 | 197 cm | 165 cm     |               |                           | 40 kg                | 250 kg           |
| 99 cm      | 71 cm              | 69 cm         | 31 cm                          | 57 cm |                 | 197 cm | 165 cm     |               |                           | 40,5 kg              | 250 kg           |
| 95 cm      | 66 cm              | 64 cm         | 31 cm                          | 57 cm |                 | 197 cm | 165 cm     |               |                           | 42 kg                | 250 kg           |
| 99 cm      | 71 cm              | 69 cm         | 31 cm                          | 57 cm |                 | 197 cm | 165 cm     |               |                           | 43 kg                | 250 kg           |
| 95 cm      | 66 cm              | 64 cm         | 31 cm                          | 57 cm |                 | 197 cm | 165 cm     |               |                           | 44 kg                | 250 kg           |
| 99 cm      | 71 cm              | 69 cm         | 31 cm                          | 57 cm |                 | 197 cm | 165 cm     |               |                           | 45 kg                | 250 kg           |
|            |                    | 66 cm         | 64 cm                          | 31 cm | 57 cm           | 197 cm | 162 cm     |               |                           | 48 kg                | 250 kg           |
|            |                    | 71 cm         | 69 cm                          | 31 cm | 57 cm           | 197 cm | 167 cm     |               |                           | 49,5 kg              | 250 kg           |
|            |                    | 66 cm         | 64 cm                          | 31 cm | 57 cm           | 197 cm | 162 cm     |               |                           | 41 kg                | 250 kg           |
|            |                    | 71 cm         | 69 cm                          | 31 cm | 57 cm           | 197 cm | 167 cm     |               |                           | 42 kg                | 250 kg           |
| 95 cm      | 66 cm              | 64 cm         | 31 cm                          | 57 cm |                 | 197 cm |            |               |                           | 40 kg                | 250 kg           |
| 99 cm      | 71 cm              | 69 cm         | 31 cm                          | 57 cm |                 | 197 cm |            |               |                           | 41 kg                | 250 kg           |
| 123 cm     | 85,5 cm            | 0 cm          |                                | 60 cm |                 | 197 cm | 166 cm     |               |                           | 45,9 kg              | 320 kg           |
| 92 cm      | 66 cm              | 60 cm         | 32,5 cm                        | 56 cm |                 | 195 cm | 169 cm     |               |                           | 43 kg                | 250 kg           |
| 92 cm      | 66 cm              | 60 cm         | 32,5 cm                        | 56 cm |                 | 195 cm | 166 cm     |               |                           | 44 kg                | 250 kg           |
| 92 cm      | 66 cm              | 60 cm         | 32,5 cm                        | 56 cm |                 | 195 cm | 166 cm     |               |                           | 44 kg                | 250 kg           |
| 91,5 cm    | 66 cm              | 60 cm         | 31 cm                          | 56 cm |                 | 196 cm | 167 cm     |               |                           | 35,1 kg              | 250 kg           |
| 87,5 cm    | 65 cm              | 45 cm         | 26 cm                          | 56 cm |                 | 194 cm | 162 cm     |               |                           | 34 kg                | 170 kg           |
| 87,5 cm    | 65 cm              | 62 cm         | 26 cm                          | 56 cm |                 | 194 cm | 155 cm     |               |                           | 37 kg                | 170 kg           |
| 87,5 cm    | 65 cm              | 45 cm         | 26 cm                          | 56 cm |                 | 194 cm | 162 cm     |               |                           | 37 kg                | 170 kg           |
| 87,5 cm    | 65 cm              | 62 cm         | 26 cm                          | 56 cm |                 | 194 cm | 155 cm     |               |                           | 40 kg                | 170 kg           |
| 90,5 cm    | 62 cm              |               | 30 cm                          | 56 cm |                 | 197 cm |            |               |                           | 37 kg                | 170 kg           |
| 90,5 cm    | 62 cm              |               | 30 cm                          | 56 cm |                 | 197 cm |            |               |                           | 37 kg                | 170 kg           |
| 92 cm      | 60 cm              |               | 25 cm                          | 56 cm |                 | 197 cm |            |               |                           | 47,5 kg              | 350 kg           |

# MERCURY

## LITE 4

AMBULANCE COT IN ALUMINIUM  
WITH VARIABLE HEIGHT AND 4  
SWIVEL CASTORS



Bariatric



Pediatric



Trauma



Art. 7080/4RG PROOF

### MERCURY LITE 4

Ambulance cot in aluminium with variable height and 4 swivel castors

Our "Mercury Lite" stretcher is available in the 4 swivel castors version, ensuring excellent manoeuvrability. This device is ideal for narrow spaces. The two front castors can be unblocked by means of an intuitive mechanism. They can revert to their original non-rotating position. The fastening of the stretcher inside of an emergency vehicle is ensured by our product Art. 955 Proof, certified UNI EN 1789 (see "Fastening Systems"). The stretcher is supplied with mattress, straps and object holder. **Device certified according to the European harmonized safety standards UNI EN 1865 – UNI EN 1789.**

Art. 7082/4RG PROOF

### MERCURY LITE 4

Ambulance cot in aluminium with variable height and 4 swivel castors – high version

Sharing the same features of the 7080/4RG Proof model, this version is easily loaded on higher emergency vehicles. Supplied with the same accessories as 7080/4RG. **Device certified according to the European harmonized safety standards UNI EN 1865 – UNI EN 1789.**



Front castors release lever

Rotating front castors



Intermediate position



## Ambulance cot Mercury Lite 4 accessories

See **ACCESSORIES**  
at page 88

### Technical Data

| Art.           | Colour | Material          | Adjustable height | Trendelenburg | Intermediate height | Max height | Max loading height | Min loading height | Folded height | Width | Length | Min length | Weight  | Loading capacity |
|----------------|--------|-------------------|-------------------|---------------|---------------------|------------|--------------------|--------------------|---------------|-------|--------|------------|---------|------------------|
| 7080/4RG PROOF | ■      | Painted aluminium | ✓                 | ✓             | 72 cm               | 95 cm      | 66 cm              | 64 cm              | 31 cm         | 57 cm | 197 cm | 165 cm     | 40 kg   | 250 kg           |
| 7082/4RG PROOF | ■      | Painted aluminium | ✓                 | ✓             | 75 cm               | 99 cm      | 71 cm              | 69 cm              | 31 cm         | 57 cm | 197 cm | 165 cm     | 40,5 kg | 250 kg           |

# MERCURY

STAINLESS STEEL CERTIFIED AMBULANCE COT WITH VARIABLE HEIGHT



Bariatric



Pediatric



Trauma



Art. 7070 PROOF

## MERCURY

Stainless steel ambulance cot with variable height

Designed to fit a variety of configurations, this ambulance cot is provided with a multi-level system with 2 pistons on each axle. The fastening of the stretcher inside of an emergency vehicle is ensured by our product Art. 955 Proof, certified UNI EN 1789 (see "Fastening Systems").

**Device certified according to the European harmonized safety standards UNI EN 1865 – UNI EN 1789.**

Art. 7072 PROOF

## MERCURY

Stainless steel ambulance cot with variable height - high version

This model shares the same features of art. 7070, but also allows loading on higher emergency vehicles. **Device certified according to the European harmonized safety standards UNI EN 1865 – UNI EN 1789.**



### Unique Features

- ✓ Ergonomic control for loading operations and for set-up adjustments
- ✓ Adjustable backrest with lockable gas spring for 0° - 75° inclination
- ✓ Fully foldable 600 mm side rails
- ✓ HDPE bumpers (both on front and back legs)
- ✓ 2 fixed front castors Ø 200 mm with brakes
- ✓ 2 self-centring back swivel castors (360°) Ø 200 mm
- ✓ 2 load castors Ø 150 mm (easy loading system)
- ✓ Supplied with mattress (Art. 7013), 2 straps (Art. 608-A/MEB or 608-N/MEB) and 1 strap (Art. 612/AN-2/MEB or Art. 612/N-2/MEB)
- ✓ Supplied with multi-purpose object holder (Art. 12025).

Loaded position



Accessories

**Art. 955 PROOF**

Fastening system for ambulance cots



## Mercury stretcher accessories

See **ACCESSORIES**  
at page 88

| Art.       | Colour | Material        | Adjustable height | Trendelenburg | Intermediate height | Max height | Max loading height | Min loading height | Folded height | Width | Length | Min length | Weight | Loading capacity |
|------------|--------|-----------------|-------------------|---------------|---------------------|------------|--------------------|--------------------|---------------|-------|--------|------------|--------|------------------|
| 7070 PROOF | ■      | Stainless steel | ✓                 | ✓             | 72 cm               | 95 cm      | 66 cm              | 64 cm              | 31 cm         | 57 cm | 197 cm | 165 cm     | 42 kg  | 250 kg           |
| 7072 PROOF | ■      | Stainless steel | ✓                 | ✓             | 75 cm               | 99 cm      | 71 cm              | 69 cm              | 31 cm         | 57 cm | 197 cm | 165 cm     | 43 kg  | 250 kg           |



# MERCURY 4

VARIABLE HEIGHT STAINLESS STEEL CERTIFIED AMBULANCE COT WITH 4 SWIVEL CASTORS



Bariatric Pediatric Trauma



Art. 7070/4RG PROOF

## MERCURY4

Variable height stainless steel certified ambulance cot with 4 swivel castors

Our "Mercury" stretcher is available in the 4 swivel castors version, ensuring excellent manoeuvrability. This device is ideal for narrow spaces. The two front castors can be unblocked by means of an intuitive mechanism. They can be reverted to their original non-rotating position. The stretcher is supplied with mattress, straps and object holder.

**Device certified according to the European harmonized safety standards UNI EN 1865 – UNI EN 1789.**

Art. 7072/4RG PROOF

## MERCURY4

Variable height stainless steel certified ambulance cot with 4 swivel castors – high version

Sharing the same features of the 7070/4RG Proof model, this version is easily loaded on higher emergency vehicles. The stretcher is supplied with mattress, straps and object holder. **Device certified according to the European harmonized safety standards UNI EN 1865 – UNI EN 1789.**

Front castors release lever

Rotating front castors



Intermediate position



Loaded position

## Mercury 4 Ambulance Cot accessories

See **ACCESSORIES**  
at page 88

### Technical Data

| Art.              | Colour | Material        | Adjustable height | Trendelenburg | Intermediate height | Max height | Max loading height | Min loading height | Folded height | Width | Length | Min length | Weight | Loading capacity |
|-------------------|--------|-----------------|-------------------|---------------|---------------------|------------|--------------------|--------------------|---------------|-------|--------|------------|--------|------------------|
| 7070/4RG<br>PROOF | ■      | Stainless steel | ✓                 | ✓             | 72 cm               | 95 cm      | 66 cm              | 64 cm              | 31 cm         | 57 cm | 197 cm | 165 cm     | 44 kg  | 250 kg           |
| 7072/4RG<br>PROOF | ■      | Stainless steel | ✓                 | ✓             | 75 cm               | 99 cm      | 71 cm              | 69 cm              | 31 cm         | 57 cm | 197 cm | 165 cm     | 45 kg  | 250 kg           |

# MERCURY CINQUE

STAINLESS STEEL  
CERTIFIED AMBULANCE  
COT, 5 HEIGHTS,  
4 SWIVEL CASTORS



Bariatric



Pediatric



Trauma



NEW  
PRODUCT

Art. 7075/4RG PROOF

## MERCURY Cinque

Stainless steel certified ambulance cot, 5 heights,  
4 swivel castors

Mercury Cinque stems from one of our most successful projects in the emergency sector, surely our most valued product, the Mercury 4RG. Mercury Cinque aims at further extending the operational capacity of the original model thanks to the introduction of the 5 level system, namely the 5 height feature. However, Mercury Cinque is much more than sheer evolution: it is the only stretcher with 5 heights and foldable front trolley and the only ambulance cot that can grant a load capacity of 250 kg on all 5 levels. Supplied with mattress, straps and a multi-purpose object holder. **Device certified according to the European harmonized safety standards UNI EN 1865 – UNI EN 1789.**

NEW  
PRODUCT

Art. 7077/4RG PROOF

## MERCURY Cinque

Stainless steel certified ambulance cot, 5 heights, 4 swivel castors - high version

Sharing the same features of the 7075/4RG Proof model, this version is easily loaded on higher emergency vehicles. The stretcher is supplied with mattress and straps. **Device certified according to the European harmonized safety standards UNI EN 1865 – UNI EN 1789.**



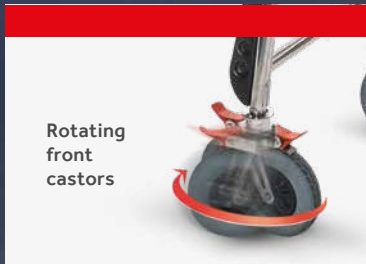
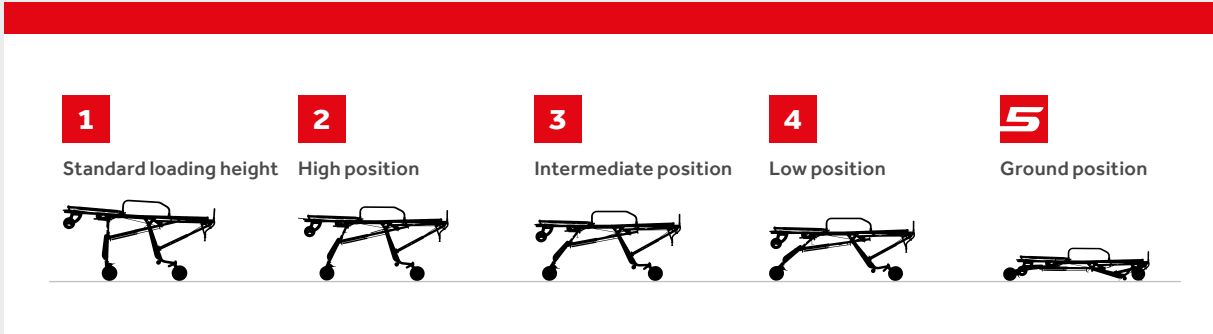

Rotating front castors



Mercury Cinque accessories

See **ACCESSORIES** at page 88

| Art.           | Colour | Material        | Adjustable height | Trendelenburg | Height                     | Max loading height | Min loading height | Folded height | Width | Length | Folded trolley length | Weight  | Loading capacity |
|----------------|--------|-----------------|-------------------|---------------|----------------------------|--------------------|--------------------|---------------|-------|--------|-----------------------|---------|------------------|
| 7075/4RG PROOF | ■      | Stainless steel | ✓                 | ✓             | 95 - 87 - 79 - 68 - 37 cm  | 66 cm              | 64 cm              | 31 cm         | 57 cm | 197 cm | 167 cm                | 48 kg   | 250 kg           |
| 7077/4RG PROOF | ■      | Stainless steel | ✓                 | ✓             | 101 - 91 - 82 - 70 - 39 cm | 71 cm              | 69 cm              | 31 cm         | 57 cm | 197 cm | 167 cm                | 49,5 kg | 250 kg           |

# MERCURY CINQUE LITE



Bariatric



Pediatric



Trauma



NEW  
PRODUCT

Art. 7095/4RG PROOF

## MERCURY Cinque LITE

Certified Aluminium ambulance cot, 5 heights,  
4 swivel castors

Entirely built in aluminium, this stretcher varies from the Mercury Cinque Art. 7075/4RG Proof and Art. 7077/4RG Proof (both in stainless steel) because of its light weight. This ambulance cot is provided with a multi-level system with 2 pistons on each axle. The aluminium tops are resistant, durable and easily cleanable. The fastening of the stretcher inside of an emergency vehicle is ensured by our product Art. 955 Proof, certified UNI EN 1789 (see "Fastening Systems"). Supplied with mattress, straps and a multi-purpose object holder. **Device certified according to the European harmonized safety standards UNI EN 1865 – UNI EN 1789.**

NEW  
PRODUCT

Art. 7097/4RG PROOF

## MERCURY Cinque LITE

Certified Aluminium  
ambulance cot, 5 heights,  
4 swivel castors – high version

Sharing the same features of the 7095/4RG Proof model, this version is easily loaded on higher emergency vehicles. The stretcher is supplied with mattress, straps and multi-purpose object holder. **Device certified according to the European harmonized safety standards UNI EN 1865 – UNI EN 1789.**



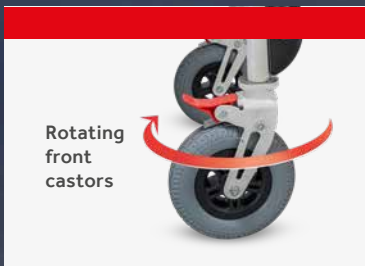
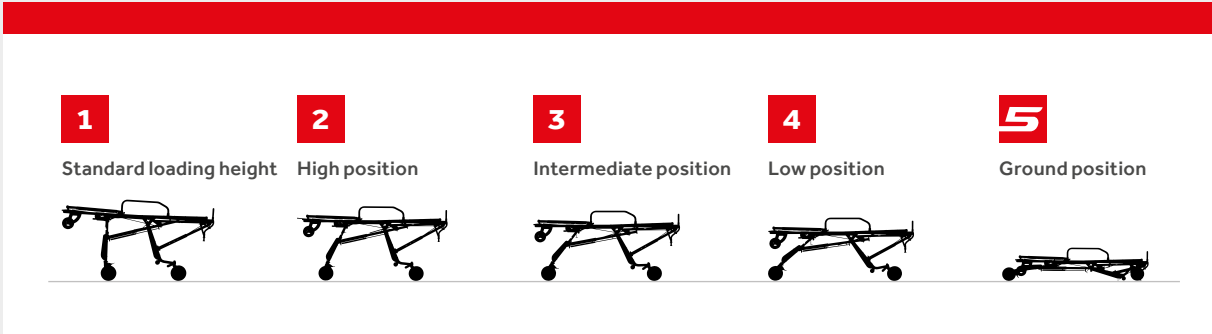

Rotating front castors



Height adjustment lever

Front swivel castors release lever

## Mercury Cinque Lite accessories

See **ACCESSORIES** at page 88

### Technical Data

| Art.           | Colour | Material          | Adjustable height | Trendelenburg | Height                     | Max loading height | Min loading height | Folded height | Width | Length | Folded trolley length | Weight | Loading capacity |
|----------------|--------|-------------------|-------------------|---------------|----------------------------|--------------------|--------------------|---------------|-------|--------|-----------------------|--------|------------------|
| 7095/4RG PROOF | ■      | Painted aluminium | ✓                 | ✓             | 95 - 87 - 79 - 68 - 37 cm  | 65 cm              | 63 cm              | 31 cm         | 57 cm | 197 cm | 167 cm                | 41 kg  | 250 kg           |
| 7097/4RG PROOF | ■      | Painted aluminium | ✓                 | ✓             | 101 - 91 - 82 - 70 - 39 cm | 70 cm              | 68 cm              | 31 cm         | 57 cm | 197 cm | 167 cm                | 42 kg  | 250 kg           |

# MERCURY EL

CERTIFIED SELF-LOADING STRETCHER



Bariatric



Pediatric



Trauma



Art. 7092 PROOF

## MERCURY EL

Certified self-loading stretcher

Mercury EL is the newest entry in Me.Ber's range of ambulance cots. Sharing many features from other Mercury models, the EL is a naturally highly reliable and versatile cot. This model represents the entry level for the Mercury line: unlike most Mercury models, the EL does not feature a foldable front trolley nor 4 swivel castors and it's not multilevel. However, this version serves as a perfect solution when a high standard of quality must be met while keeping things easy and accessible. Complete with mattress and belts.

**Device certified according to the European harmonized safety standards UNI EN 1865 – UNI EN 1789.**



Art. 7094 PROOF

## MERCURY EL

Certified self-loading stretcher - high version

Sharing the same features of the 7092 PROOF model, this version is easily loaded on higher emergency vehicles. Complete with mattress and belts.

**Device certified according to the European harmonized safety standards UNI EN 1865 – UNI EN 1789.**





Backrest supported with hydraulic ram, adjustable on infinite positions



## Self-loading stretcher accessories Mercury EL certified

See **ACCESSORIES**  
at page 88

### Technical Data

| Art.          | Color | Material      | Trendelenburg | Max height | Max loading height | Min loading height | Folded height | Width | Length | Weight | Loading capacity |
|---------------|-------|---------------|---------------|------------|--------------------|--------------------|---------------|-------|--------|--------|------------------|
| 7092<br>PROOF | ■     | Painted steel | ✓             | 95 cm      | 66 cm              | 64 cm              | 31 cm         | 57 cm | 197 cm | 40 kg  | 250 kg           |
| 7094<br>PROOF | ■     | Painted steel | ✓             | 99 cm      | 71 cm              | 69 cm              | 31 cm         | 57 cm | 197 cm | 41 kg  | 250 kg           |



# MEBER-X

MULTI-LEVEL STRETCHER WITH MATTRESS AND STRAPS



Bariatric



Pediatric



Trauma



Art. 7300  
complete with  
accessories



Art. 7300

## MEBER-X

Multi-level stretcher with mattress and straps

The multi-level stretcher MEBER-X, with its X-shaped frame, belongs to our new White Line: it has been designed to facilitate loading, unloading, translation, lifting and dropping of a patient. Its main feature is the possibility to be adjusted at 9 different heights, supporting transfers and manoeuvrability under all conditions. Built in a special aluminium alloy, this stretcher has a 320 kg load capacity, ensuring maximum safety for the transport of bariatric patients. Further characteristics of this device include: 4 swivel castors with 200 mm diameter, 2 with brakes; loading bed in aluminium, easily cleanable; backrest inclination from 0° to 80°, lockable in any position; Fowler and Trendelenburg positions; retractable loading trolley. **Supplied with: Mattress Art. 7002, Straps Art. 608-A/MEB or Art. 608-N/MEB (2 pieces) and Strap Art. 612/AN-2/MEB or Art. 612/N-2/MEB (1 piece).**

Supplied  
with

**Art.  
7002**

Electro-welded  
4 pieces black  
mattress



**Art.  
612/N-2/MEB**

Black chest belt with  
4-buckles system

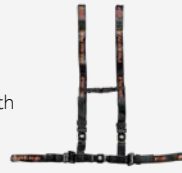

**Art. 608-N/MEB**

2 x 2-pieces black straps with  
metal buckle



**Art. 980**

Cot fastening system  
composed of front and side  
fixing and rear safety hook



**Art. 12018N**

P-120 - Telescopic Infusion Pole for  
ambulance cots



**Art. 12120**

Lower - Black objects holder  
for MEBER-X  
(Size: 92x43 cm)



**Art. 12122**

Upper - Black objects holder  
for MEBER-X  
(Size: 39x52 cm)



**Art. 12100/N**

Black Pillow for MEBER-X  
headrest



**Art. 12128**

Adjustable length  
system for MEBER-X  
headrest

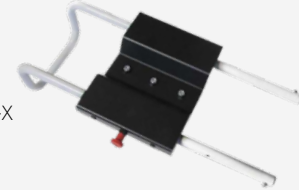

Accessories

## MEBER-X self-loading stretcher accessories

See **ACCESSORIES**  
at page 88

### Technical Data

| Art. | Colour | Material          | Adjustable height | Trendelenburg | Fowler | Multi-level | Min height | Max height | Max loading height | Min loading height | Width | Length | Min length | Weight  | Loading capacity |
|------|--------|-------------------|-------------------|---------------|--------|-------------|------------|------------|--------------------|--------------------|-------|--------|------------|---------|------------------|
| 7300 | ■      | Painted aluminium | ✓                 | ✓             | ✓      | ✓           | 40,5 cm    | 123 cm     | 85,5 cm            | 0 cm               | 60 cm | 197 cm | 166 cm     | 45,9 kg | 320 kg           |

| Art. |          | Intermediate height 1 | Intermediate height 2 | Intermediate height 3 | Intermediate height 4 | Intermediate height 5 | Intermediate height 6 | Intermediate height 7 | Intermediate height 8 | Intermediate height 9 |
|------|----------|-----------------------|-----------------------|-----------------------|-----------------------|-----------------------|-----------------------|-----------------------|-----------------------|-----------------------|
| 7300 | Backrest | 123 cm                | 114,5 cm              | 106 cm                | 96,5 cm               | 87 cm                 | 77,5 cm               | 67 cm                 | 55,5 cm               | 40,5 cm               |
|      | Feet     | 91 cm                 | 90,5 cm               | 88 cm                 | 85 cm                 | 81 cm                 | 76 cm                 | 69 cm                 | 59 cm                 | 43 cm                 |
|      | Loading  | 84 cm                 | 76 cm                 | 67 cm                 | 58 cm                 | 48 cm                 | 38,5 cm               | 29 cm                 | 17 cm                 | 0 cm                  |

# FROG LITE PROOF

STAINLESS STEEL  
AMBULANCE  
COT WITH  
TRENDELENBURG



Bariatric



Pediatric



Trauma



Art. 7260 PROOF

## FROG Lite PROOF

Self loading aluminium stretcher with trendelenburg certified

Entirely built in robust painted aluminium, this extremely light ambulance cot is also provided with Trendelenburg. 4 Ø 200 mm castors in polyurethane (2 fixed with brakes and 2 self-aligning swivels) offer a high level of comfort on uneven floors and surfaces. This device is easy to clean and disinfect. Together with the fastening system 955 proof, the device can absorb the inertial stresses caused by sudden acceleration or deceleration of the rescue vehicle. Supplied with mattress and straps (Art. 7013, 2 pieces of Art. 608-A/MEB or 608-N/MEB and 1 strap Art. 612/AN-2/MEB or Art. 612/N-2/MEB).

**Device certified according to the European harmonized safety standards UNI EN 1865 – UNI EN 1789.**



Foldable front trolley

## Unique Features

- ✓ Rigid platform made of painted aluminium alloy
- ✓ Reclining backrest 0°-80°, operated by a gas piston, lockable in any position
- ✓ Folding sides
- ✓ Vertical legs protected by plastic buffets
- ✓ Rotating wheels are self centring
- ✓ Collapsable frontal trolley

Loaded position



Trendelenburg position



Supplied with



### Art. 7013

Electro-welded 3 pieces fire-proof skai mattress



### Art. 608-A/MEB - 608-N/MEB



Black or Orange belt in 2 pieces with metal buckle and Meber Logo (155 cm)

### Art. 612/N-2/MEB 612/AN-2/MEB



Orange/black adjustable chest belt with 4-buckles systems for ambulance cots or chairs

## Frog Lite PROOF self-loading stretcher accessories

See **ACCESSORIES** at page 88

### Technical Data

| Art.       | Color | Material             | Height  | Max loading height | Min loading height | Altezza piegata | Width | Length | Min length | Weight  | Loading capacity |
|------------|-------|----------------------|---------|--------------------|--------------------|-----------------|-------|--------|------------|---------|------------------|
| 7260 PROOF | ■     | Alluminio verniciato | 91,5 cm | 66 cm              | 60 cm              | 31 cm           | 56 cm | 196 cm | 167 cm     | 35,1 kg | 250 kg           |

# FROG

YELLOW  
AMBULANCE  
COT WITH  
TRENDELENBURG

# TRENDELENBURG



Bariatric



Pediatric



Trauma

Art. 7210

## FROG

Yellow ambulance cot with Trendelenburg

Entirely built in powder-coated steel, this device is extremely resistant and reliable. The remarkable smoothness of the 4 Ø 200 mm castors (2 fixed with brakes and 2 self-aligning swivel castors) ensure high comfort to the patient. This model is equipped with Trendelenburg, from 0° to 20°.

Frog  
accessories

See **ACCESSORIES**  
at page 88

| Art.       | Colour | Material      | Trendelenburg | Height | Max loading height | Min loading height | Folded height | Width | Length | Length with folded trolley | Weight | Loading capacity |
|------------|--------|---------------|---------------|--------|--------------------|--------------------|---------------|-------|--------|----------------------------|--------|------------------|
| 7210       | ■      | Painted steel | ✓             | 92 cm  | 66 cm              | 60 cm              | 32,5 cm       | 56 cm | 195 cm | 169 cm                     | 43 kg  | 250 kg           |
| 7210 PROOF | ■      | Painted steel | ✓             | 92 cm  | 66 cm              | 60 cm              | 32,5 cm       | 56 cm | 195 cm | 166 cm                     | 44 kg  | 250 kg           |

## Unique Features



- ✓ Loading bed in reinforced thermoplastic
- ✓ Reclining backrest 0°-80°, operated by a gas piston, lockable in any position
- ✓ Foldable side rails
- ✓ Vertical legs with cot bumpers
- ✓ Swivel castors with self-aligning system to ensure positioning of the cot on the emergency vehicle without manual turning of the castors
- ✓ Foldable Front trolley for volume reduction
- ✓ Trendelenburg.



Art. 7210PROOF

## FROG Proof

**Certified yellow Ambulance cot with Trendelenburg**

Sharing the very same characteristics of Art. 7210, this model is supplied with mattress and straps (Art. 7013, 2 straps Art. 608-A/MEB or 608-N/MEB and 1 strap Art. 612/AN-2/MEB or Art. 612/N-2/MEB). Combined with the fastening system 955 Proof, this device can endure 10G stress. **Device certified according to the European harmonized safety standards UNI EN 1865 – UNI EN 1789.**

Frog Proof accessories

See **ACCESSORIES** at page 88

Supplied with



### Art. 7013

3 pieces  
fire-proof  
electro-welded  
Skai mattress



### Art. 608-A/MEB - 608-N/MEB



Orange or black strap in 2 pieces with metal buckle and Me.Ber. logo (155 cm length)

### Art. 612/N-2/MEB 612/AN-2/MEB



Orange/black adjustable chest belt with 4-buckle systems for ambulance cots or chairs

# FROG PLUS TRENDELENBURG

SELF-LOADING STRETCHER IN STAINLESS STEEL WITH TRENDELENBURG



Bariatric



Pediatric



Trauma



Art. 7240 PROOF

## FROG Plus PROOF

Self loading stretcher with trendelenburg certified

Made of electropolished stainless steel, it is equipped with 4 Ø 200 mm wheels (2 fixed with brake and 2 self-centering swivel).

The inclination of the legs has been designed to give the stretcher better stability during use. The Trendelenburg position is operated by a gas piston which can be locked in any position from 0° to 20°. The rigidity of the structure guarantees resistance to the inertial stresses of the emergency vehicle on which it is transported. Supplied complete with mattress (Art. 7013 and belts nr. 2 Art. 608-A/MEB o 608-N/MEB and nr. 1 Art. 612/AN-2/MEB or Art. 612/N-2/MEB). **Device certified according to the European harmonized standards UNI EN1865 - UNI EN1789**

| Art.       | Colour | Material        | Trendelenburg | Height | Max loading height | Min loading height | Folded height | Width | Length | Length with folded trolley | Weight | Loading capacity |
|------------|--------|-----------------|---------------|--------|--------------------|--------------------|---------------|-------|--------|----------------------------|--------|------------------|
| 7240 PROOF | ■      | Stainless steel | ✓             | 92 cm  | 66 cm              | 60 cm              | 32,5 cm       | 56 cm | 195 cm | 166 cm                     | 44 kg  | 250 kg           |

## Unique Features

- ✓ Rigid platform made of reinforced thermoplastic material.
- ✓ Reclining backrest 0°- 80°, operated by a gas piston, can be locked in any position.
- ✓ Folding sides.
- ✓ Vertical legs protected by plastic buffers.
- ✓ Casters are self-centring so that the stretcher can be positioned in the ambulance without them having to be turned manually.
- ✓ Front trolley can be lowered to reduce overall dimensions of the stretcher.



### Frog Plus PROOF self-loading stretcher accessories

See **ACCESSORIES**  
at page 88

Supplied with



#### Art. 7013

3 pieces  
fire-proof  
electro-welded  
Skai mattress



#### Art. 608-A/MEB - 608-N/MEB



Orange or black strap in 2 pieces  
with metal buckle and Me.Ber. logo  
(155 cm length)

#### Art. 612/N-2/MEB 612/AN-2/MEB



Orange/black adjustable chest belt  
with 4-buckles systems for ambulance  
cots or chairs



# FROG INC

INCUBATOR TRANSPORTER



Pediatric



Art. 7240/INC PROOF

## FROG Plus INC Proof

Incubator transporter "FROG PLUS" with fastening system configuration (10G)

Integrating the configuration for the certified fastening system Art. 955 Proof, this model is ideal for incubator transport on emergency vehicles. Without backrest, side rails nor rigid loading bed, this device belongs to the "FROG PLUS" line.



Art.  
7240/INC PROOF  
+ 12048



Art.  
7240/INC PROOF  
+ 12050

| Art.           | Colour | Material          | Height | Max loading height | Min loading height | Folded height | Width | Length | Length with folded trolley | Weight  | Loading capacity |
|----------------|--------|-------------------|--------|--------------------|--------------------|---------------|-------|--------|----------------------------|---------|------------------|
| 7240/INC PROOF | ■      | Stainless steel   | 82 cm  | 66 cm              | 60 cm              | 27 cm         | 56 cm | 195 cm | 166 cm                     | 38 kg   | 250 kg           |
| 7260/INC PROOF | □      | Painted aluminium | 83 cm  | 66 cm              | 60 cm              | 26 cm         | 56 cm | 196 cm | 166 cm                     | 27,5 kg | 250 kg           |



Art. 7260/INC PROOF

## FROG Lite INC Proof

Incubator transporter with fastening system configuration (10G)

This device belongs to the "FROG LITE" line, sharing the very same features of the other models, such as reliability, safety and durability. Built in painted aluminium, without backrest, side rails nor rigid loading bed. It is ideal for incubator transport on emergency vehicles.



Art. 12048

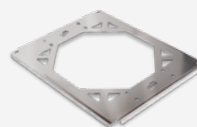

Certified 10G interface for incubator housing

Art. 12050



Extended interface for incubator housing



# WINNER

# GIN

AMBULANCE COT  
FOR INCUBATOR  
TRANSPORT

Art. 910/GIN



Pediatric



Art. 910/  
GIN PROOF



Art. 910/GIN

## WINNER GIN

Incubator transporter "WINNER"

Designed for the housing and transport of an incubator on emergency vehicles, this device belongs to the "Winner" line. Entirely built in anodized aluminium.

Art. 910/GIN PROOF

## WINNER GIN Proof

Incubator transporter "WINNER" with configuration for certified fastening system

Entirely built in anodized aluminium, this device shares the same characteristics of Art. 910/GIN and additionally features the configuration for the certified fastening system Art. 955 Proof.

| Art.          | Colour | Material           | Height | Max loading height | Min loading height | Folded height | Width | Length | Length with folded trolley | Weight | Loading capacity |
|---------------|--------|--------------------|--------|--------------------|--------------------|---------------|-------|--------|----------------------------|--------|------------------|
| 910/GIN       | ■      | Anodized aluminium | 80 cm  | 65 cm              | 45 cm              | 22 cm         | 56 cm | 194 cm | 162 cm                     | 28 kg  | 170 kg           |
| 910/GIN PROOF | ■      | Anodized aluminium | 80 cm  | 65 cm              | 62 cm              | 22 cm         | 56 cm | 194 cm | 155 cm                     | 31 kg  | 170 kg           |

# FIXED TROLLEY FOR INCUBATOR HOUSING



Pediatric

Art. 7034

## Fixed trolley for incubator housing

Fixed height trolley with stainless steel frame, 4 castors  $\varnothing$  200 mm (2 with brakes) for incubator transport inside hospitals. Reduced size for optimal manoeuvrability. Supplied with universal incubator interface.



Pediatric

Accessories

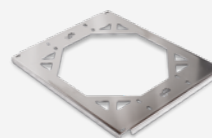

Art. 12048

Certified 10G  
interface for  
incubator housing

| Art. | Colour | Material     | Height | Width | Length | Weight  |
|------|--------|--------------|--------|-------|--------|---------|
| 7034 | ■      | Acciaio inox | 74 cm  | 57 cm | 90 cm  | 30,5 kg |

# TITANUS4

STAINLESS STEEL VARIABLE HEIGHT CERTIFIED AMBULANCE TROLLEY WITH 4 SWIVEL CASTORS



Art. 7060/4RG PROOF

## TITANUS4

Stainless steel variable height certified ambulance trolley with 4 swivel castors

The 4 swivel castors option is available for the TITANUS trolley: the TITANUS 4 shares the same features of Art. 7060 Proof. **Device certified according to the European harmonized safety standards UNI EN 1865 – UNI EN 1789.**

Art. 7062/4RG PROOF

## TITANUS4

Stainless steel variable height certified ambulance trolley with 4 swivel castors – high version

Sharing the same features of the 7060/4RG Proof model, this version is easily loaded on higher emergency vehicles. **Device certified according to the European harmonized safety standards UNI EN 1865 – UNI EN 1789.**



Intermediate Position

Art. 7060/4RG + 1510 PROOF



Front castors release lever



Front swivel castors



### Technical Data

| Art.           | Colour | Material        | Adjustable height | Intermediate height | Max height | Max loading height | Min loading height | Folded height | Width | Rear axle width | Length | Folded length | Weight  | Loading capacity |
|----------------|--------|-----------------|-------------------|---------------------|------------|--------------------|--------------------|---------------|-------|-----------------|--------|---------------|---------|------------------|
| 7060/4RG PROOF | ■      | Stainless steel | ✓                 | 61 cm               | 84 cm      | 64 cm              | 60 cm              | 25 cm         | 44 cm | 56 cm           | 197 cm | -             | 36,5 kg | 220 kg           |
| 7062/4RG PROOF | ■      | Stainless steel | ✓                 | 61 cm               | 89 cm      | 72 cm              | 68 cm              | 25 cm         | 44 cm | 56 cm           | 197 cm | 200 cm        | 37 kg   | 220 kg           |

# EVOX

CERTIFIED  
CHAIR COT

# PROOF

Unlimited  
Adjustments



Art. 7112 PROOF

## EVOX PROOF

EVOX Certified Chair Cot with mattress

The EVOX Chair Cot allows to place the patient in the most suitable position during rescue and transport. By converting into chair, this device ensures access to narrow entrances, tight aisles and elevators, where a regular Ambulance Cot won't fit. A gas piston system regulates the unlimited adjustments up to the sitting position, relieving the operator from any efforts to move the patient. The frame is entirely built in electro-polished stainless steel. The chair cot features Ø 200mm polyurethane castors, safety command to prevent accidental closure. The mattress is split in 4 separate sections (one for each portion of the cot's loading bed). All of these features, together with the cot's captivating design, are strong points of this device, which is experiencing increasing demand on the market. Its innovative load system, with its 4 swivel castors, facilitates the loading on a variety of supports and many different heights. Thanks to the mushroom head-lock together with the fastening system Art. 962, **the EVOX Chair Cot Art. 7112 PROOF is capable of enduring 10G stress in all directions, as per UNI EN 1789.** The ability to accommodate patients in the most appropriate position (depending on the seriousness of the injury) makes the EVOX chair cot a perfect fit for emergency waiting rooms, where the patients may be requested to queue for a long time. **Supplied with 1 mattress Art. 7009/A or 7009/N and 2 straps Art. 608-A/MEB or 608-N/MEB.**

Supplied with\*

**Art. 7009/N -  
Art. 7009/A**

Electro-welded  
mattress, orange  
or black, for EVOX  
Chair Cot



**Art. 608-A/MEB - Art. 608-N/MEB**



Orange or black strap in 2 pieces with metal  
buckle and Me.Ber. logo (155 cm length)

(\* ) Supplied with 1 mattress and 2 straps (to be chosen among available colours)



Chair Cot  
without  
Mattress

Accessories

**Art. 12016E**



Foldable telescopic Infusion Pole  
for EVOX Proof Chair Cot.

**Art. 12100/N**



Black Electro-welded headrest with  
MeBer logo for electro-welded  
mattress

**Art. 962**



EVOX PROOF Chair Cot  
fastening system (EN 1789)

### Technical Data

| Art.          | Colour | Material           | Height | Max loading height | Folded height | Width | Length | Folded length | Chair position<br>min length | Weight  | Loading capacity |
|---------------|--------|--------------------|--------|--------------------|---------------|-------|--------|---------------|------------------------------|---------|------------------|
| 7112<br>PROOF | ■      | Stainless<br>steel | 80 cm  | 67 cm              | 27 cm         | 60 cm | 193 cm | 198 cm        | 123 cm                       | 44,5 kg | 220 kg           |



# GECKO

ENTRY-LEVEL  
AMBULANCE  
COT

Art. 7122/V

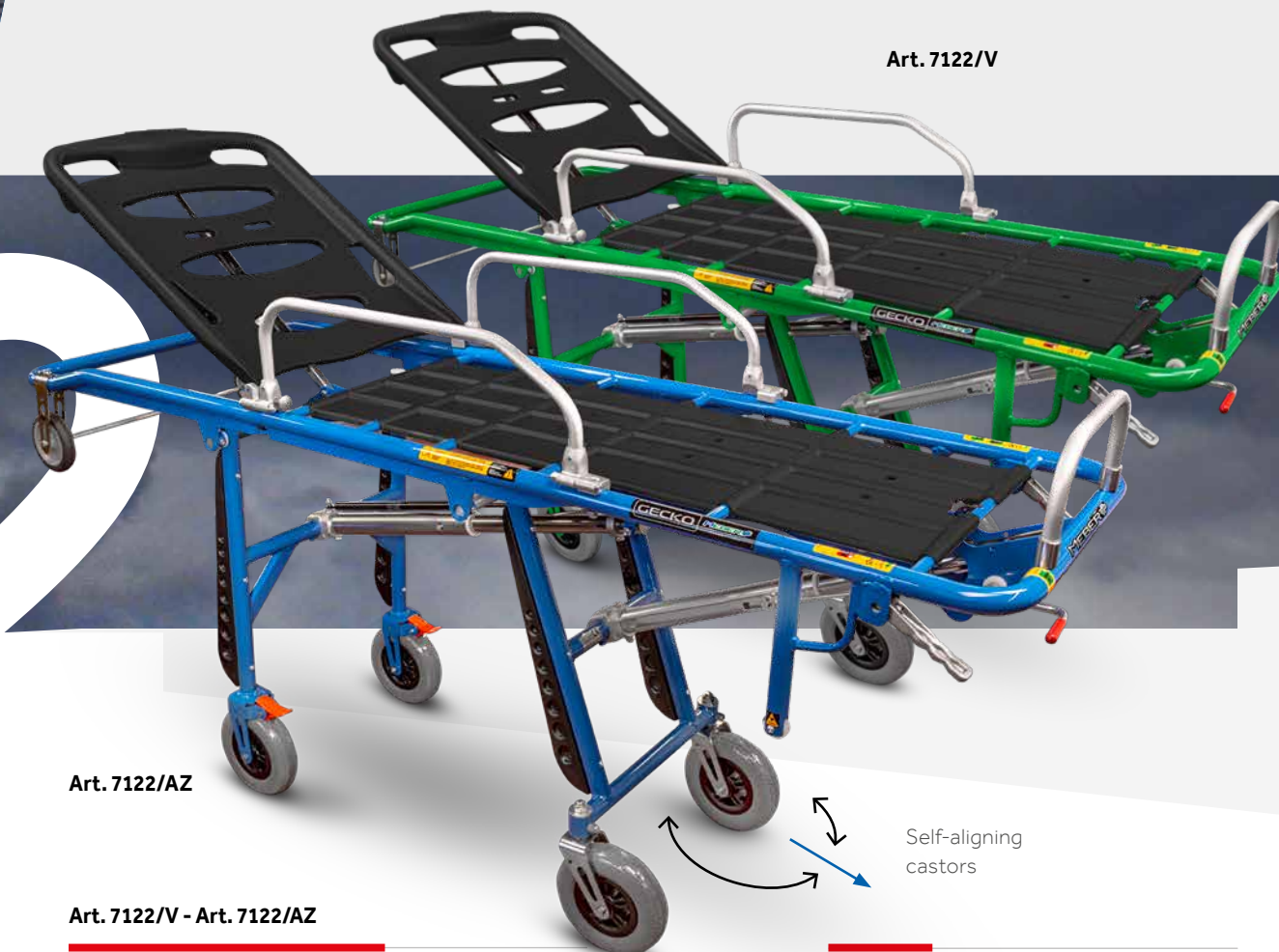

Art. 7122/AZ

Art. 7122/V - Art. 7122/AZ

## GECKO

### Green/light blue entry-level ambulance cot

Designed to optimize quality/ratio, this stretcher is entirely built in high-resistance painted steel. This model features all characteristics of regular ambulance cots: adjustable backrest, 4 Ø 200 mm castors (2 with brakes and 2 self-aligning swivel castors), foldable side rails. Supplied with straps.

### Gecko accessories

See **ACCESSORIES** at page 88

Accessories

Art. 7016/A



One-piece electro-welded orange mattress in PVC

Art. 965



Front fastening system for ambulance cot

Art. 950/3

(H. 148 mm)



Rear fastening system for ambulance cot

Supplied with

Art. 603/MEB



Supplied with straps

| Art.   | Colour | Material      | Height  | Max loading height | Folded height | Width | Length | Weight | Loading capacity |
|--------|--------|---------------|---------|--------------------|---------------|-------|--------|--------|------------------|
| 7122/V |        | Painted steel | 90,5 cm | 62 cm              | 30 cm         | 56 cm | 197 cm | 37 kg  | 170 kg           |

# MBS-01

## AMBULANCE COT FOR BARIATRIC TRANSPORT



Art. 7270 +  
Extension Wings art.12084 +  
Mattress art.12170 e art. 12172 +  
Mattress art.7013/N

Art. 7270 +  
Top art. 12080 +  
Mattress art. 7015 +  
Strap roller art. 560



Bariatric

### MBS-01 ambulance cot accessories

See **ACCESSORIES**  
at page 88

Art. 7270

## MBS-01

### Ambulance cot for bariatric transport

Specifically designed for **bariatric transport**, the MBS-01 is built in **high resistance stainless steel**. The **reinforced** frame ensures a load **capacity of 350 kg**, which is **higher** than all cots in MeBer's range and features **2 front Ø 125x25 mm castors and 2 rear Ø 100x25 mm castors** for maximum safety during loading and unloading. The model features 4 Ø 200x50 mm castors, 2 with brakes and 2 self-aligning swivel castors, ensuring maximum comfort to the patient. The rigid loading bed is built in reinforced thermoplastic, making it easily cleanable. The device features a reclining backrest (0°-80°) operated by a gas spring, lockable in any position, and foldable side rails. The legs are protected by cot bumpers. Supplied with mattress and straps (Art. 7013, 2 straps Art. 608-A/MEB or 608-N/MEB and 1 strap Art. 612/AN-2/MEB or

612/N-2MEB). The higher load capacity makes this stretcher a **perfect fit for the MBP bariatric loading bed** (art. 12080) and the bariatric wing set (art. 12084). **Device certified according to the European harmonized safety standards UNI EN 1865 – UNI EN 1789.**

Accessories

#### Art. 12080

MBP wide bariatric loading bed for ambulance cots

Specify the cot model when ordering this accessory



| Art.          | Colour | Material        | Height | Max loading height | Folded height | Width | Length | Weight  | Loading capacity |
|---------------|--------|-----------------|--------|--------------------|---------------|-------|--------|---------|------------------|
| 7270<br>PROOF | ■      | Stainless steel | 92 cm  | 60 cm              | 25 cm         | 56 cm | 197 cm | 47,5 kg | 350 kg           |

# WINNER

AMBULANCE  
COT

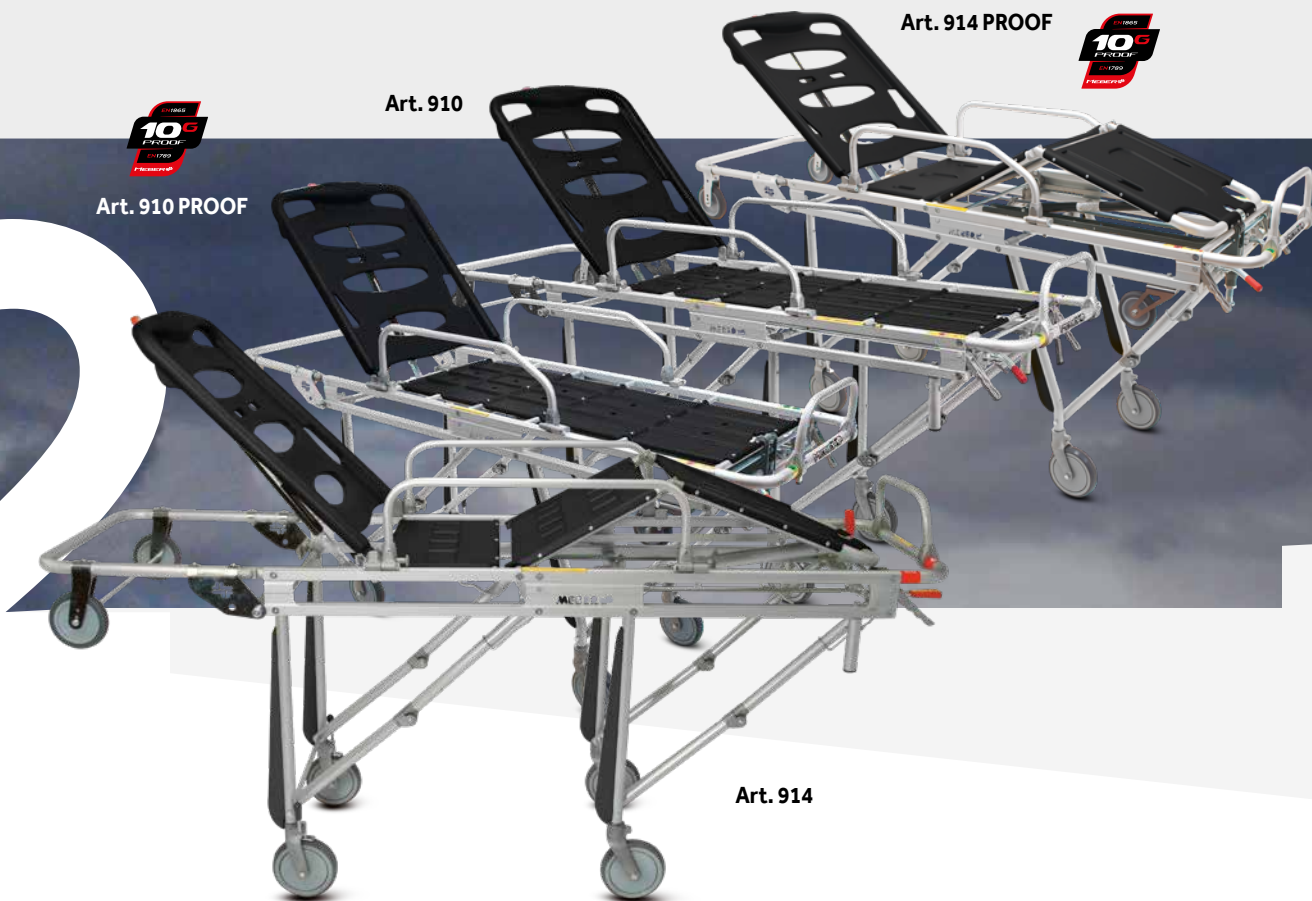

Art. 910 - Art. 910 PROOF - Art. 914 - Art. 914 PROOF

## Winner

910 - Ambulance cot

914 - Ambulance cot with Trendelenburg and Fowler position

Entirely built in anodized aluminium, these models feature 4 150 mm castors (rear, self-aligning), adjustable backrest 0°-80°, foldable side rails, legs protected by cot bumpers. Sturdy and manoeuvrable.

Also available in the "PROOF" certified version (UNI EN 1865 – UNI EN 1789).

| Art.      | Colour | Material           | Trendelenburg | Height  | Max loading height | Min loading height | Folded height | Length with folded trolley | Width | Length | Weight | Loading capacity |
|-----------|--------|--------------------|---------------|---------|--------------------|--------------------|---------------|----------------------------|-------|--------|--------|------------------|
| 910       | ■      | Anodized aluminium |               | 87,5 cm | 65 cm              | 45 cm              | 26 cm         | 162 cm                     | 56 cm | 194 cm | 34 kg  | 170 kg           |
| 910 PROOF | ■      | Anodized aluminium |               | 87,5 cm | 65 cm              | 62 cm              | 26 cm         | 155 cm                     | 56 cm | 194 cm | 37 kg  | 170 kg           |
| 914       | ■      | Anodized aluminium | ✓             | 87,5 cm | 65 cm              | 45 cm              | 26 cm         | 162 cm                     | 56 cm | 194 cm | 37 kg  | 170 kg           |
| 914 PROOF | ■      | Anodized aluminium | ✓             | 87,5 cm | 65 cm              | 62 cm              | 26 cm         | 155 cm                     | 56 cm | 194 cm | 40 kg  | 170 kg           |

# CARRY AND STAIR CHAIRS



MeBer has a whole line of carry- and stair-chairs. These devices are vital on emergency vehicles of all kinds, because they allow access to areas where cots can't fit (narrow spaces, elevators, tight stairs, high buildings). These models were developed thanks to the experience and support of rescue operators from all over the world: our range is highly

appreciated for the quality of the materials, for their movement accuracy and above all for their 10G certification (UNI EN 1865 – UNI EN 1789) which ensures safety when installed on emergency vehicles. The Stair-Chair EXTRA re-defined the market standards thanks to unique innovations implemented and to the use of extremely light materials.

Discover MeBer Chairs on-line. Shoot the QR code with your tablet or smartphone to land on the dedicated page on the website. You might be required to install a free application to navigate.

Alternatively, go to:  
<https://www.meber.it/en/products/sedan-chairs.aspx>



# CARRY AND STAIR CHAIRS

**B**



| Article code | Name              | Model   |
|--------------|-------------------|---|
| 671          | EXTRA ERGOLIFT    | Powered Stair Chair                                     |
| 675          | EXTRA ERGOLIFT FX | Fixed Frame Powered Stair Chair                         |
| 670/BR       | EXTRA             | Track Assisted Stair Chair                              |
| 676          | EXTRA LITE        | STANDARD Folding Stair Chair                            |
| 678          |                   | BASIC Folding Stair Chair                               |
| 679          |                   | ZENA Small Folding Stair Chair                          |
| 668          | KUMA              | Black Powered Stair Chair                               |
| 658/Y        | QUICK             | Folding black and yellow stair chair with 2 wheels      |
| 659/Y        |                   | Folding stair chair with footrest and armrest, 4 wheels |
| 650          | MAYA              | Stair Chair   |
| 653          |                   | Stair Chair with 4 wheels, footrest and armrest         |
| 683          | PROXIMA PRO       | Padded stair chair with footrest and armrest            |

Material: ◆ Stainless steel ◆ Painted steel ◆ Anodized aluminium ◆ Painted aluminium

# COMPARATION CHART



| Colour | 10G Certification | Material          | Seat height | Height | Folded height | Width    | Min length | Max length | Folded thickness | Weight  | Loading capacity |
|--------|-------------------|-------------------|-------------|--------|---------------|----------|------------|------------|------------------|---------|------------------|
| ■      | ✓                 | Painted aluminium | 50 cm       | 104 cm | -             | 55 cm    | 84 cm      | 150 cm     | 29 cm            | 32 kg   | 230 kg           |
| ■      |                   | Painted aluminium | 50 cm       | 140 cm | -             | 55 cm    | 84 cm      | 150 cm     | -                | 44,8 kg | 230 kg           |
| ■      | ✓                 | Painted aluminium | 50 cm       | 101 cm | -             | 55 cm    | 81 cm      | 139 cm     | 29 cm            | 20,3 kg | 230 kg           |
| ■      | ✓                 | Painted aluminium | 50 cm       | 101 cm | -             | 55 cm    | 78 cm      | 139 cm     | 29 cm            | 13,9 kg | 200 kg           |
| ■      | ✓                 | Painted aluminium | 50 cm       | 101 cm | -             | 55 cm    | 76 cm      | 139 cm     | 29 cm            | 13,6 kg | 200 kg           |
| ■      |                   | Painted aluminium | 56 cm       | 102 cm | -             | 47/50 cm | 65 cm      | 122 cm     | 29 cm            | 13,8 kg | 230 kg           |
| ■      |                   | Painted aluminium | 50 cm       | 108 cm | -             | 52 cm    | 79 cm      |            | 24 cm            | 34 kg   | 181 kg           |
| ■      | ✓                 | ◆                 | 49 cm       | 90 cm  | -             | 51 cm    | 71 cm      | 126 cm     | 23 cm            | 10 kg   | 170 kg           |
| ■      | ✓                 | ◆                 | 50 cm       | 90 cm  | 99 cm         | 51 cm    | 71 cm      | 126 cm     | 23 cm            | 14 kg   | 170 kg           |
| ■      | ✓                 | ◆                 | 51 cm       | 91 cm  | -             | 52 cm    | 74 cm      | 128 cm     | 24 cm            | 10 kg   | 170 kg           |
| ■      | ✓                 | ◆                 | 52 cm       | 90 cm  | 98 cm         | 52 cm    | 75 cm      | 131 cm     | 24 cm            | 14 kg   | 170 kg           |
| ■      | ✓                 | ◆                 | 50 cm       | 118 cm | -             | 57 cm    | 90 cm      | 163 cm     | -                | 21 kg   | 170 kg           |

# EXTRA ERGO LIFT

POWERED  
STAIR CHAIR



Art. 671

## EXTRA Ergolift

Powered Stair Chair

Extra Ergolift is the powered version of our Extra stair chair: it shares the very same structural characteristics of the Extra, such as a light aluminium frame, front and rear telescopic handgrips, coated armrest, front footrest, long and high-grip sliding tracks (allowing to balance the patient between 3 steps on 4 wheels), 2 rear Ø 200 mm castors and 2 swivel Ø 125 mm front ones. The real innovation of the Extra Ergolift lies in the electric motor that powers the tracks, thus facilitating the climb and descent of the patient on

the stairs and reducing the operator's physical effort. The motor is activated by means of a wireless console. The long-running battery ensures completion of the descent in case of sudden discharge. Extra Ergolift has a load capacity of 230 kg and may be used under adverse weather conditions. The device weighs 32 kg. **Device certified according to the European harmonized safety standard UNI EN 1789.**

**Art. 12016-S**

Foldable Telescopic Infusion Pole for Extra and Extra Ergo-lift Chairs



**Art. 975**



Extra Ergolift fastening system



**Art. 671-001**

Black breathable dust sheet for Extra Ergolift chairs



**Art. 670-004**

Ø 200 mm castor's clamp with brake for Extra chair



**Art. 670-001**

Headrest for Extra Stair chair



**Art. 566**

Black bag with 3 two-pieces black straps and MeBer logo in orange for Extra stair chair



**Art. 12090**

MILWAUKEE Battery Charger M28C for M28RED re-chargeable battery for Extra Ergolift Stair Chair



**Art. 12092**

MILWAUKEE M28RED Lithium Battery 5.0 Ampere for Extra Ergolift Stair Chair



Supplied with



Battery housing support



Wireless console

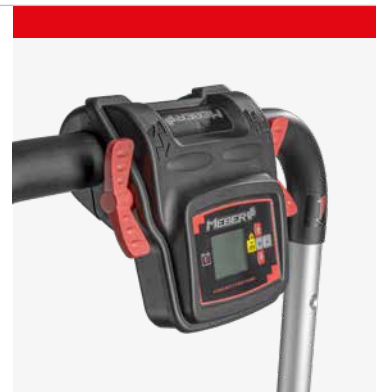

| Art. | Material          | Length    | Width | Height | Seat height | Weight | Loading capacity | Battery | Folded thickness | Autonomy                                   | Charging time |
|------|-------------------|-----------|-------|--------|-------------|--------|------------------|---------|------------------|--|---------------|
| 671  | Painted aluminium | 84-150 cm | 55 cm | 104 cm | 50 cm       | 32 kg  | 230 kg           | 28 V    | 29 cm            | 18 ramps by 20 steps with a load of 130 kg | max 1 hour    |



# EXTRA ERGO LIFT

## FX

FIXED FRAME POWERED STAIR CHAIR



Chair lock  
release lever



Art. 675

## EXTRA Ergolift FX

Fixed Frame Powered Stair Chair

Extra Ergolift FX is the fixed frame version of the powered stair chair Extra Ergolift. The two models share the same structural characteristics, such as light frame, telescopic front handgrips, wireless console, coated armrest, long and high-grip sliding tracks, footrest, small and simple electric motor. What characterizes this model is that the rescued patient can be carried to the final destination without transhipments. As a matter of fact, this device is homologated for transport on emergency vehicles as well as assistive vehicles.

Some of the main features include: high and stuffed backrest, for a safe and comfortable seating position.

Chest belt with 4-buckles system, 200 mm rear castors, telescopic grab bar, long-running battery. The EXTRA Ergolift FX has a 230 kg load capacity and may be used in adverse weather conditions. The device weighs 44,8 kg. 28V battery, duration of approximately 18 flights with 20 steps, carrying 130 kg. Fully charged in max 1 hour.

**Device certified according to the European harmonized safety standard UNI EN 1789** (with fastening system Art. 988).

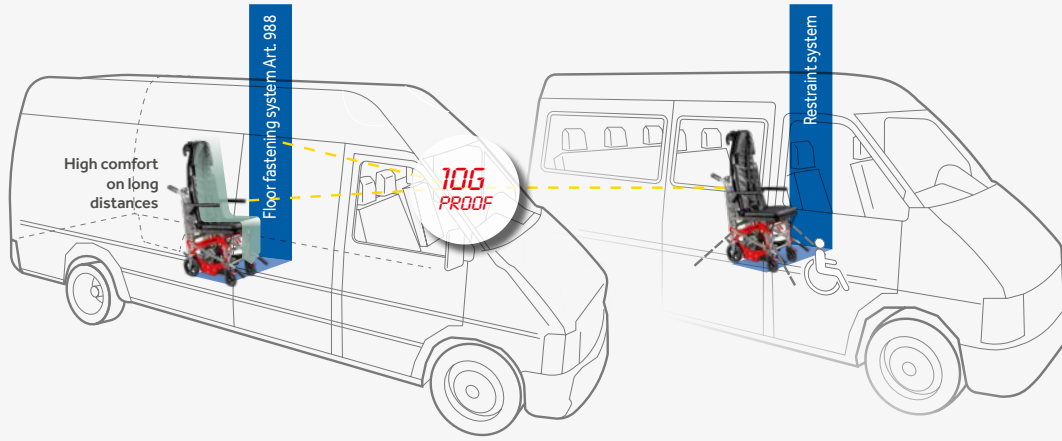

**Art. 988**



Fastening system for Extra Ergolift FX chair

**Art. 12090**



MILWAUKEE Battery Charger M28C for M28RED re-chargeable battery for Extra Ergolift Stair Chair

**Art. 12092**



MILWAUKEE M28RED Lithium Battery 5.0 Ampere for Extra Ergolift Stair Chair

**Art. 610**



Chest-belt with 4-buckles system for Extra Ergolift FX

**Art. 12118**



Mattress

**Art. 566**



Black bag with 3 two-pieces straps, black background with orange MeBer Logo for Extra Ergolift



| Art. | Material          | Length    | Width | Height | Seat height | Weight  | Loading capacity | Battery | Autonomy                                   | Charging time |
|------|-------------------|-----------|-------|--------|-------------|---------|------------------|---------|--|---------------|
| 675  | Painted aluminium | 84-150 cm | 55 cm | 140 cm | 50 cm       | 44,8 kg | 230 kg           | 28 V    | 18 ramps by 20 steps with a load of 130 kg | max 1 hour    |

# EXTRA

STAIR  
CHAIR



Art. 670/BR

## EXTRA

### Stair Chair

EXTRA is a track-assisted stair chair by MeBer. Entirely built in aluminium, this device is one of the lightest models available on the market. The inclination of both the backrest and the rear handgrips, as well as the special configuration of the telescopic handles, ensure a perfect weight distribution, facilitating the operator's work. The long high-grip tracks allow to balance the chair on 3 steps, making the EXTRA an extraordinarily safe and manoeuvrable chair during the descent of a seated patient. During transport on flat surfaces, the rear 200 mm castors and the front

125 mm ones ensure high comfort and handiness. Coming with 2 coated armrests and a telescopic grab bar, the comfort of this chair is unparalleled. To complete the features of this outstanding device, the EXTRA introduces a foldable footrest with magnetic blocking system and a few innovative bio-mechanical solutions, way ahead of the regular stair chairs. As an optional, the two rear castors can be supplied with brakes. **Device certified according to the European harmonized safety standards UNI EN 1865 – UNI EN 1789.**



Closed chair



Supplied with



Art. 566



Black bag with 3 two-pieces black straps and MeBer logo in orange for Extra stair chair

Fastening Systems



Art. 975



ERGOLIFT FASTENING SYSTEM. Fastening system for Extra Ergolift, Extra (foldable) and Zena

Art. 960



EXTRAFASTENING SYSTEM. Fastening system for EXTRA stair chair, certified UNI EN 1789

Accessories



Art. 670-001

Headrest and immobilizer for Extra stair chair



Art. 670-002

Black breathable dust sheet for Extra Ergolift chairs



Art. 670-004

Ø 200 mm castor's clamp with brake for Extra chair



Art. 12016-S

Foldable Telescopic Infusion Pole for Extra and Extra Ergolift Chairs



| Art.   | Material          | Seat height | Height | Width | Min length | Max length | Folded thickness | Weight  | Loading capacity |
|--------|-------------------|-------------|--------|-------|------------|------------|------------------|---------|------------------|
| 670/BR | Painted aluminium | 50 cm       | 101 cm | 55 cm | 81 cm      | 139 cm     | 29 cm            | 20,3 kg | 230 kg           |

# EXTRA LITE

FOLDABLE  
STAIR CHAIR



Art. 678

Art. 678

## EXTRA LITE Basic

### Stair Chair

EXTRA LITE basic is Meber's stair chair entirely built in light aluminium, currently among the lightest models on the market. The rear handgrips and the unique front handles' design ensure a perfect weight distribution, facilitating the operator's job. The backrest and seat positioning offer extraordinary comfort to the patient. During transfer on flat surfaces, the rear 200 mm castors and the front 125 mm ones offer great manoeuvrability. **Device certified according to the European harmonized safety standards UNI EN 1865 – UNI EN 1789.**



Art. 676

Art. 676

## EXTRA LITE Standard

### Foldable 4 wheels Stair Chair with footrest and armrest

The EXTRA LITE standard shares the same features of Art. 678. Foldable footrest with magnetic lock and the armrests complete this device. **Device certified according to the European harmonized safety standards UNI EN 1865 – UNI EN 1789.**



**Art. 566**



**Supplied with**

Black bag with 3 two-pieces black straps and MeBer logo in orange for Extra stair chair

**Art. 975**



**Fastening Systems**

ERGOLIFT FASTENING SYSTEM. Fastening system for Extra Ergolift, Extra (foldable) and Zena



**Art. 960**



**EXTRA FASTENING SYSTEM.** Fastening system for EXTRA stair chair, certified UNI EN 1789



**Art. 670-002**



**Accessories**

Black breathable dust sheet for Extra Ergolift chairs

**Art. 670-004**



Ø 200 mm castor's clamp with brake for Extra chair

**Technical data**

| Art. | Material          | Seat height | Height | Width | Min length | Max length | Folded thickness | Weight  | Loading capacity |
|------|-------------------|-------------|--------|-------|------------|------------|------------------|---------|------------------|
| 676  | Painted aluminium | 50 cm       | 101 cm | 55 cm | 78 cm      | 139 cm     | 29 cm            | 13,9 kg | 200 kg           |
| 678  | Painted aluminium | 50 cm       | 101 cm | 55 cm | 78 cm      | 139 cm     | 29 cm            | 13,6 kg | 200 kg           |

# EXTRA LITE

# ZENA

SMALL FOLDING  
STAIR CHAIR



Art. 679

## EXTRA LITE ZENA

**Small Folding Stair Chair, 4 wheels, with footrest, armrest and aluminium tops**

Extra Lite Zena was designed to be employed in tight and narrow spaces, such as public transport vehicles (Buses, trains, airplanes, etc.), elevators and tight staircases. Entirely built in aluminium, this device is easily manoeuvrable and extremely light, among the lightest in Me.Ber's range. Seat and backrest are coated in expanded EVA, to ensure maximum comfort and easy cleaning. Foldable, featuring telescopic front handles and foldable rear handgrips, this Stair Chair is perfect when you need to reduce volume; the ZENA Stair Chair can be installed on an emergency vehicle by means of the **fastening system Art. 960, certified EN 1789**. Further characteristics of this device include 2 front 125 mm castors with brakes, 2 200 mm rear castors, coated armrests and foldable footrest. Weight: 13,8 kg

**Device certified according to the European harmonized safety standards UNI EN 1865 – UNI EN 1789.**

| Art. | Material        | Seat height | Height | Min length | Max length | Min width | Max width | Folded thickness | Weight  | Loading capacity |
|------|-----------------|-------------|--------|------------|------------|-----------|-----------|------------------|---------|------------------|
| 679  | Aluminium alloy | 56 cm       | 102 cm | 65 cm      | 122 cm     | 47 cm     | 50 cm     | 29 cm            | 13,8 kg | 230 kg           |

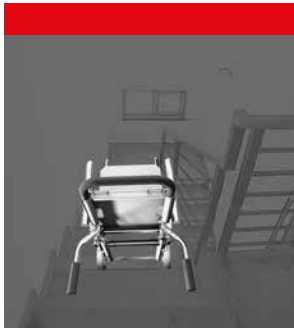

Old buildings



Trains and buses

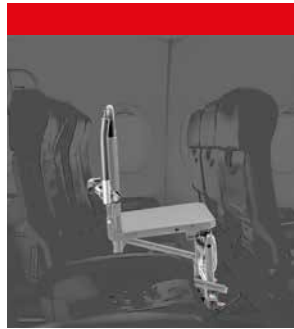

Airplanes



Service Elevators



29  
cm

Folded Chair

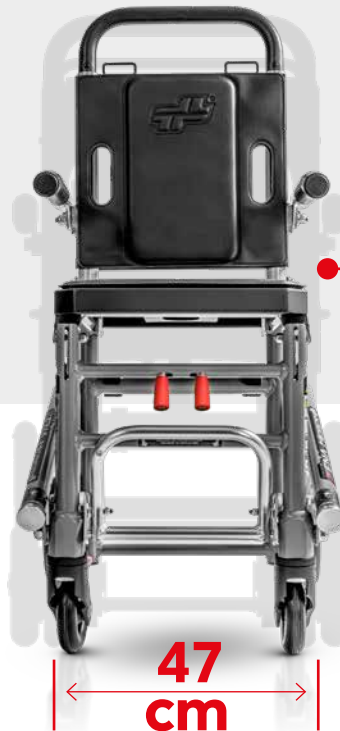

47  
cm

Volume comparison with a regular stair chair

Accessories

Art. 171J  
(Left)



Telescopic handgrips for Extra Stair Chairs

Art. 172J  
(Right)

Art. 612/AN-2/MEB  
Art. 612/N-2/MEB



Orange/black adjustable chest belt with 4-buckles systems for ambulance cots or chairs

Art. 842L



Rear handles lock and release system for Zena

Fastening Systems

Art. 960



EXTRA FASTENING SYSTEM. Fastening system for EXTRA stair chair, certified UNI EN 1789



Art. 975



ERGOLIFT FASTENING SYSTEM. Fastening system for Extra Ergolift, Extra (foldable) and Zena



Supplied with

Art. 566

Black bag with 3 two-pieces black straps and MeBer logo in orange for Extra stair chair





# KUMA

POWERED STAIR CHAIR



NEW PRODUCT

Art. 668

## KUMA

### Black powered stair chair

Kuma is the entry level model in MeBer's line of powered stair chairs. Frame in aluminium, lithium-ion battery powered, front handgrips, ergonomic armrests, telescopic grab bar (with a small console for track speed control) and 4 castors (2 fixed rear Ø200 mm with brakes and 2 front swivels castors Ø125 mm). The electric motor operates the tracks, allowing an effortless ascent and descent of the stairs. Kuma has a 181 kg load capacity. Supplied with battery, battery charger, seat cushion, headrest, chest belt, ventral belt. Practical and easy to manoeuvre, the KUMA is extremely easy to use. Colour: black.



Art. 12180

Battery

NEW PRODUCT



Art. 12182

Battery charger

NEW PRODUCT



Accessories

Art. 977

Fastening system for KUMA Powered Stair Chair

NEW PRODUCT

10 YEARS WARRANTY



Fastening Systems

| Art. | Material          | Seat height | Height       | Length | Width | Folded thickness | Weight | Loading capacity |
|------|-------------------|-------------|--------------|--------|-------|------------------|--------|------------------|
| 668  | Painted aluminium | 50 cm       | 108 - 164 cm | 79 cm  | 52 cm | 24 cm            | 34 kg  | 181 kg           |

# PROXIMA

# PRO

PADDED  
STAIR CHAIR



Art. 683

## PROXIMA Pro

**Padded Stair Chair, built in aluminium and certified UNI EN 1865**

Entirely built in aluminium, this stair chair is notable for its light weight. Padded fire-proof seat and backrest, coated in Skai to ensure easy cleaning and comfort. Equipped with 4 Ø 150 mm castors (2 rear swivel castors with brakes and 2 fixed front castors), 2 rear handgrips, 4 telescopic handles (2 front and 2 rear, Ø 35 mm for ease of movement) and foldable coated armrests for maximum comfort. Supplied with chest belt. Dedicated fastening system Art. 988 UNI EN 1789 available as accessory (see "Fastening Systems").

**Device certified according to the European harmonized safety standards  
UNI EN 1865 – UNI EN 1789.**

| Art. | Colour  | Material          | Seat height | Height | Width | Min length | Max length | Weight | Loading capacity |
|------|---|-------------------|-------------|--------|-------|------------|------------|--------|------------------|
| 683  |  | Painted aluminium | 50 cm       | 118 cm | 57 cm | 90 cm      | 163 cm     | 21 kg  | 170 kg           |

Art. 988



Fastening System for Extra  
Ergolift FX and Proxima Pro

Accessories



# QUICK 659

FOLDABLE STAIR CHAIR



B

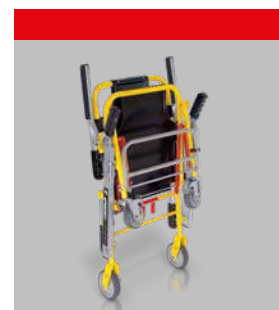

Art. 659/Y

## QUICK

**Black/Yellow Foldable Stair Chair with 4 castors, footrest and armrest**

The QUICK is a crucial device for rescue operators. Equipped with 4 castors (2 fixed Ø 125 mm rear castors and 2 swivel Ø 100 mm front castors with brakes), foldable armrests, foldable footrest, 4 rear handgrips and 2 front telescopic handles.

The backrest and seat are built in easily-cleanable thermoplastics. Supplied with black bag containing 3 straps (Art. 590/N).

**Device certified according to the European harmonized safety standards UNI EN 1865 – UNI EN 1789.**

| Art.  | Colour | Material      | Seat height | Height | Folded height | Width | Min length | Max length | Folded thickness | Weight | Loading capacity |
|-------|--------|---------------|-------------|--------|---------------|-------|------------|------------|------------------|--------|------------------|
| 659/Y | ■      | Painted steel | 50 cm       | 90 cm  | 99 cm         | 51 cm | 71 cm      | 126 cm     | 23 cm            | 14 kg  | 170 kg           |
| 658/Y | ■      | Painted steel | 49 cm       | 90 cm  | -             | 51 cm | 71 cm      | 126 cm     | 23 cm            | 10 kg  | 170 kg           |

# QUICK 658

FOLDABLE STAIR CHAIR



Art. 658/Y

## QUICK

### Black/Yellow Foldable Stair Chair with 2 castors

Designed for a safe transport. Easily closed/opened. Thanks to a unique mechanism, the chair cannot be closed by mistake. Equipped with 2 Ø 125 mm castors, two rear handgrips and 2 front telescopic handles, this device is extremely manoeuvrable. The backrest and the seat are built in easily-cleanable thermoplastics. Supplied with black bag containing 3 straps (Art. 590/N).

**Device certified according to the European harmonized safety standards UNI EN 1865 – UNI EN 1789.**

Supplied with

Art. 590/N



Black bag containing 3 black straps

Fastening Systems

Art. 618



Fastening System for Stair chair (See FASTENING SYSTEMS)

Accessories

Art. 612/AN-2/MEB Art. 612/N-2/MEB

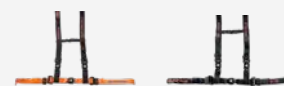

Orange/black adjustable chest belt with 4-buckles systems for ambulance cots or chairs

# MAYA 653

FOLDABLE STAIR CHAIR



Art. 653

## MAYA

**Foldable Stair Chair with 4 castors, footrest and armrest**

Designed to help rescue operators during rescue procedures. Entirely built in anodized aluminium. Equipped with 4 castors (2 swivel castors with brakes Ø 100 mm and 2 fixed castors Ø 125 mm), a unique open/close system, 4 rear handgrips and 2 front telescopic handles, backrest and seat in thermoplastics, footrest. Supplied with black bag containing 3 straps (Art. 590/N).

**Device certified according to the European harmonized safety standards UNI EN 1865 – UNI EN 1789.**

| Art. | Colour | Material           | Seat height | Height | Folded height | Width | Min length | Max length | Folded thickness | Weight | Loading capacity |
|------|--------|--------------------|-------------|--------|---------------|-------|------------|------------|------------------|--------|------------------|
| 653  | ■      | Anodized aluminium | 52 cm       | 90 cm  | 98 cm         | 52 cm | 75 cm      | 131 cm     | 24 cm            | 14 kg  | 170 kg           |
| 650  | ■      | Anodized aluminium | 51 cm       | 91 cm  | -             | 52 cm | 74 cm      | 128 cm     | 24 cm            | 10 kg  | 170 kg           |

# MAYA 650

FOLDABLE STAIR CHAIR



Art. 650

## MAYA

### Foldable Stair Chair

Designed to serve as a crucial device for patients' transport, this model is entirely built in anodized aluminium. Equipped with 4 handgrips (2 rear handgrips and 2 front telescoping handles), 2 fixed castors Ø 125 mm. Intuitive open/close mechanism to avoid accidental closure of the chair. Supplied with black bag containing 3 straps (Art. 590/N).

**Device certified according to the European harmonized safety standards UNI EN 1865 – UNI EN 1789.**

Supplied  
with

Art. 590/N



Black bag containing  
3 black straps

Fastening  
Systems

Art. 618



Fastening System for Stair chair  
(See FASTENING SYSTEMS)

Accessories

Art. 612/AN-2/MEB Art. 612/N-2/MEB



Orange/black adjustable chest  
belt with 4-buckles systems for  
ambulance cots or chairs

# ACCESSORIE

## COMPARATION CHART

# 4

The high quality standard offered by Me.Ber.'s devices is naturally completed by the complementary accessories. Mattresses, for example, are a crucial component of our projects, as they offer comfort and safety while adapting to the characteristics of the devices they are paired with. Besides mattresses, we offer a rich selection of bags, cases and instrument holders, carefully designed or selected with the support of emergency experts.



### MATTRESSES

|                 | Article Code                     | Name                             | MATTRESSES |               |      |          |               |      |      |       |       |       |   |   |   |  |
|-----------------|----------------------------------|----------------------------------|------------|---------------|------|----------|---------------|------|------|-------|-------|-------|---|---|---|--|
|                 |                                  |                                  | 7014       | 7013/A 7013/N | 7016 | 1880-001 | 7009/A 7009/N | 7002 | 7015 | 12106 | 12170 | 12172 |   |   |   |  |
| Stretchers      | 16150/G   16150/V                | ERGON                            |            |               |      |          |               |      |      |       |       |       |   |   |   |  |
|                 | 16160/G   16160/V                | ERGON JR                         |            |               |      |          |               |      |      |       |       |       |   |   |   |  |
|                 | 630   631   6200                 | MAXIMA                           |            |               |      |          |               |      |      |       |       |       |   |   |   |  |
|                 | 660                              |                                  |            |               |      |          |               |      |      |       |       |       |   |   |   |  |
|                 | 13010                            | ICARUS                           |            |               |      | ✓        |               |      |      |       |       |       |   |   |   |  |
|                 | 13018                            | CRONOS                           |            | ✓             |      |          |               |      |      |       |       |       |   |   |   |  |
|                 | 16102                            | TOBOGA                           |            |               |      |          |               |      |      |       |       |       |   |   |   |  |
|                 | 1515 PROOF                       |                                  | ✓          |               |      |          |               |      |      |       |       |       |   |   |   |  |
| Ambulance Cots  | 7080/4RG PROOF<br>7082/4RG PROOF | MERCURY LITE 4                   | ✓          | ✓             |      |          |               |      | ✓    |       |       | ✓     | ✓ | ✓ | ✓ |  |
|                 | 7070 PROOF<br>7072 PROOF         | MERCURY                          | ✓          | ✓             |      |          |               |      | ✓    |       |       | ✓     | ✓ | ✓ | ✓ |  |
|                 | 7070/4RG PROOF<br>7072/4RG PROOF | MERCURY 4                        | ✓          | ✓             |      |          |               |      | ✓    |       |       | ✓     | ✓ | ✓ | ✓ |  |
|                 | 7095/4RG PROOF                   | MERCURY 5 LITE                   | ✓          | ✓             |      |          |               |      | ✓    |       |       | ✓     | ✓ | ✓ | ✓ |  |
|                 | 7097/4RG PROOF                   |                                  | ✓          | ✓             |      |          |               |      | ✓    |       |       | ✓     | ✓ | ✓ | ✓ |  |
|                 | 7075/4RG PROOF                   | MERCURY 5                        | ✓          | ✓             |      |          |               |      | ✓    |       |       | ✓     | ✓ | ✓ | ✓ |  |
|                 | 7077/4RG PROOF                   |                                  | ✓          | ✓             |      |          |               |      | ✓    |       |       | ✓     | ✓ | ✓ | ✓ |  |
|                 | 7092 PROOF                       | MERCURY EL                       | ✓          | ✓             |      |          |               |      | ✓    |       |       | ✓     | ✓ | ✓ | ✓ |  |
|                 | 7094 PROOF                       |                                  | ✓          | ✓             |      |          |               |      | ✓    |       |       | ✓     | ✓ | ✓ | ✓ |  |
|                 | 7300                             | MEBER-X                          | ✓          |               |      |          |               |      | ✓    |       |       |       |   |   |   |  |
|                 | 7112 PROOF                       | EVOX                             |            |               |      |          |               | ✓    |      |       |       |       |   |   |   |  |
|                 | 7260 PROOF                       | FROG LITE                        | ✓          | ✓             |      |          |               |      | ✓    |       |       | ✓     | ✓ | ✓ | ✓ |  |
|                 | 7210   7210 PROOF                | FROG                             | ✓          | ✓             |      |          |               |      | ✓    |       |       | ✓     | ✓ | ✓ | ✓ |  |
|                 | 7240 PROOF                       | FROG PLUS                        | ✓          | ✓             |      |          |               |      | ✓    |       |       | ✓     | ✓ | ✓ | ✓ |  |
|                 | 7122/V<br>7122/AZ                | GECKO                            |            |               | ✓    |          |               |      | ✓    |       |       |       |   |   |   |  |
| 7270            | MBS-01                           | ✓                                | ✓          |               |      |          |               |      |      | ✓     |       | ✓     | ✓ | ✓ |   |  |
| 910   910 PROOF | WINNER                           | ✓                                | ✓          |               |      |          |               | ✓    |      |       |       |       |   |   |   |  |
| 914   914 PROOF | WINNER                           | ✓                                |            |               |      |          |               | ✓    |      |       |       |       |   |   |   |  |
| Trolleys        | 7240 INC PROOF                   | FROG INC                         |            |               |      |          |               |      |      |       |       |       |   |   |   |  |
|                 | 7260 INC PROOF                   | FROG LITE INC                    |            |               |      |          |               |      |      |       |       |       |   |   |   |  |
|                 | 910/GIN PROOF<br>910/GIN         | WINNER GIN                       |            |               |      |          |               |      |      |       |       |       |   |   |   |  |
| Stair Chairs    | 671                              | EXTRA ERGOLIFT                   |            |               |      |          |               |      |      |       |       |       |   |   |   |  |
|                 | 670/BR                           | EXTRA                            |            |               |      |          |               |      |      |       |       |       |   |   |   |  |
|                 | 678   676                        | EXTRA LITE<br>(Basic   Standard) |            |               |      |          |               |      |      |       |       |       |   |   |   |  |
| Immobilization  | 9010   9012<br>9016              | GALAXY                           |            |               |      |          |               |      |      |       |       |       |   |   |   |  |
|                 | 9016-CRI                         | GALAXY CRI                       |            |               |      |          |               |      |      |       |       |       |   |   |   |  |
|                 | 9040   9042                      | GALAXY-P                         |            |               |      |          |               |      |      |       |       |       |   |   |   |  |
|                 | 9050                             | NILIX                            |            |               |      |          |               |      |      |       |       |       |   |   |   |  |
|                 | 9104                             | NAXOS                            |            |               |      |          |               |      |      |       |       |       |   |   |   |  |
|                 | 9130                             | BABY FIX                         |            |               |      |          |               |      |      |       |       |       |   |   |   |  |
|                 | 9128                             | VACUUM BAY FIX                   |            |               |      |          |               |      |      |       |       |       |   |   |   |  |





# MATTRESSES

ELECTRO-WELDED MATTRESSES FOR AMBULANCE COTS



Art. 7014/A

## SKAI MATTRESS

Electro-welded 4 pieces fire-proof skai mattress

Ambulance cot mattress in fire-proof skai and padding. Entirely electro-welded and water-resistant, this item is suitable for all MeBer ambulance cots (EVOX excluded). Supplied with 4 belts art. 605/C. **Size: cm 186 x 47 x 9**



Art. 7013/A

Art. 7013/N



Art. 7013

## SKAI MATTRESS

Electro-welded 3 pieces fire-proof skai mattress

Same features of Art. 7014 but suitable for all MeBer ambulance cots with Trendelenburg, including CRONOS (EVOX and Art. 1515 excluded). Supplied with 3 belts art. 605/C **Size: cm 186 x 47 x 9**



Art. 1880-002

## SKAI CUSHION FOR ICARUS

Skai cushion for Icarus

Cushion for ICARUS. Inner fireproof padding, coated in anti-tear, water-resistant and fireproof skai. Double-stitched seams. **Size: cm 55x35x5**

Art. 1880-001

## MATTRESS FOR ICARUS

Mattress for Icarus

Mattress for Icarus: inner fireproof padding, coated in anti-tear, water-resistant and fireproof skai. Double-stitched seams. **Size: cm 180x55x5.**

Art. 7016/A

## PVC MATTRESS

Orange, PVC one-piece electro-welded mattress

**Size: cm 186 x 47 x 5**





Art. 7009/A - Art. 7009/N

## MATTRESS

Electro-welded mattress, orange or black, for EVOX Chair Cot

Electro-welded mattress for EVOX Chair cot in Skai and inner fire-proof padding. Equipped with straps. Split in two pieces to better adapt to the cot's various configurations. The sides are raised for a better containment of the patient.

**Dimensioni: cm 131x45x8 - 46x42x5**

Art. 12100/N

## CUSHION

Electro-welded, modeled black cushion with MeBer logo – for electro-welded mattress

Electro-welded Skai cushion with inner fire-proof padding for EVOX Chair Cot: it features eyelets for anchoring to the Mattresses Art. 7009 - 7013 - 7014. The unique shape makes it ideal for head containment and support.

**Max size: cm 25x37x12 (LxPxH)**



Art. 7009-001

## SET

Set with 4 black straps with VELCRO® for the anchoring of Art 7009 - 7013 - 7014 to the EVOX Chair Cot



Art. 7002

## MEBER-X MATTRESS

4-pieces electro-welded black mattress

Sharing the same features of Art. 7014 but suitable for all MeBer ambulance cots with Trendelenburg, including CRONOS (EVOX and Art. 1515 excluded).

**Size: cm 180 x 47 x 8**



Art. 12128

Adjustable length headrest system for MEBER-X Ambulance cot.

# BARIATRIC

ACCESSORIES FOR BARIATRIC TRANSPORT

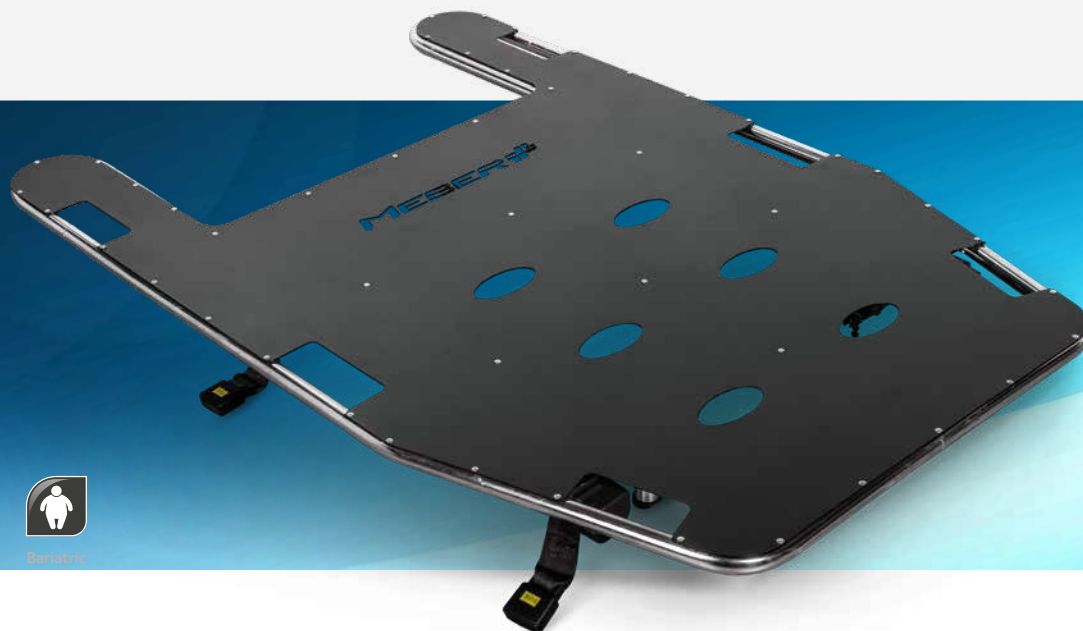

Bariatric

Art. 12080

## MBP

**Bariatric loading bed for FROG, MERCURY, GECKO and MBS-01 ambulance cots, supplied with straps and fastening system**

The MBP loading bed is compatible with all Frog, Mercury and Gecko line ambulance cots and allows to transport bariatric patients in complete safety. The stainless steel structure and the aluminium loading bed confer extreme stability and lightness at the same time. Equipped with straps (with roller) on the sides and 4 hooks for the anchoring to the cot. **Size: cm 137,5 x 93,5 x 13.**

Art. 7070/4RG PROOF + 12080



Art. 12080-001

## ASSEMBLY KIT

**Assembly kit for loading beds and bariatric wings on self-loading stretchers**

Assembly kit for loading beds and bariatric wings on self-loading stretchers ASSEMBLY KIT Kit for the assembly and fastening of a loading bed (MBP Art. 12080) and bariatric wings (art. 12084 and 12200) on self-loading stretchers MERCURY and FROG lines. Use also art. 12080-001 to install and fix the MBP bariatric loading bed (art. 12080) on Gecko self-loading stretchers. The kit includes a variety of assembly and fastening accessories, all easily adaptable and easily assembled.



# LINE



Bariatric

Art. 7015

## MBP MATTRESS

Foldable Skai mattress for MBP loading bed

Mattress for bariatric loading bed (MBP) in expanded polyurethane and black Skai coating (fireproof, water-resistant, anti-tear). Foldable in two pieces for easy storage. Equipped with 6 VELCRO® bands for the anchoring to the loading bed.

**Size: cm 173 x 96 x 5,5**

Art. 7070/4RG PROOF  
+ 12080 + 7015



Art. 12154

## BEAR PODS

"Bear Pods" Bariatric containment system for ambulance cots

The Bear Pods containment system is an accessory for the transportation of bariatric patients on ambulance cots. The Bariatric Equalizing Abdominal Restraint (BEAR) is a strong light weight nylon mesh fabric which is UV resistant, chemical resistant, easy to clean, and easy to store. The purpose of this device is to facilitate the transport of bariatric patients in total safety. Bear Pods fits any type of ambulance cot thanks to its fittable straps that must be anchored to the sides of the cot's frame.

**This product can withstand up to 300 kg.**

Art. 7080/4RG PROOF  
+ 12154



Bariatric



# BARIATRIC

ACCESSORIES FOR BARIATRIC TRANSPORT



Bariatric

Art. 7270 PROOF + 12084 +  
12170 + 12172

Art. 12084 e 12200

NEW  
PRODUCT

## BARIATRIC WINGS SET FOR AMBULANCE COTS

The bariatric wings are a practical accessory that allows you to convert the self-loading stretcher into a practical bariatric recovery tool.

Thanks to the small footprint (and a weight of only 14 kg) they can be easily transported by ambulance to be used when needed. Their use allows to face in safety, and in the most adequate way possible, every recovery scenario in the presence of bariatric patients.

The kit includes two wings that extend the support surface of the stretcher by over 40 cm; assembly and disassembly on the self-loading stretcher are extremely simple and intuitive and do not require the use of tools. If mounted on our MBS01 they allow an effective load capacity of 335 kg.

**Size Art. 12084 and Art. 12200: cm 136 x 19,5 x 4 (wing alone)**



The bariatric wings can be bought separately or with kits including both the right and the left.

Cushions are included in the kit 12084 and 12200 (Art. 12170 black mattress for right bariatric wing and Art. 12172 black mattress for left bariatric wing).



Art. 7270 PROOF + 12084 +  
12170 + 12172 + 7013/N

## AVAILABLE SETS

Suitable for:

**MBS-01 FROG**  
SELF LOADING STRETCHER



Bariatric

**NEW**  
PRODUCT



Art. 12084

Bariatric wings set for self-loading stretchers complete with belts with roller and mattresses

Art. 12086

Right bariatric wing for self-loading stretchers MBS-01 and Frog complete with belts with reel.



Art. 12088

Left bariatric wing for MBS-01 and Frog self-loading stretchers complete with belts with reel.



Suitable for:

**MERCURY**  
SELF LOADING STRETCHER



Bariatric

**NEW**  
PRODUCT



Art. 12200

Set of right and left bariatric wings for mercury self-loading stretchers complete with belts with roller, mattresses and stretcher fixing kit

Art. 12202

Right bariatric wing for Mercury self-loading stretchers complete with belts with retractor and fixing kit to the stretcher.

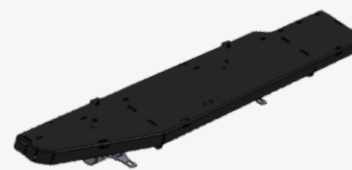

Art. 12204

Left bariatric wing for Mercury self-loading stretchers complete with belts with retractor and fixing kit to the stretcher.

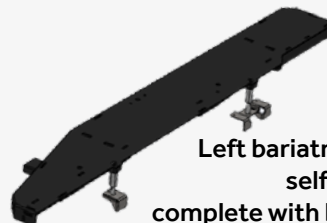

Bariatric

**NEW**  
PRODUCT



Art. 12170

Black mattress for right bariatric wing for self-loading stretchers

Comfortable black mattress for right bariatric wing. It adapts perfectly to the shape of the support and confers comfort to the bariatric patient.



Bariatric

**NEW**  
PRODUCT



Art. 12172

Black mattress for left bariatric wing for self-loading stretchers

Comfortable black mattress for left bariatric wing. It adapts perfectly to the shape of the support and confers comfort to the bariatric patient.

# HI-COM

THERAPEUTIC GEL HIGH COMFORT MATTRESS

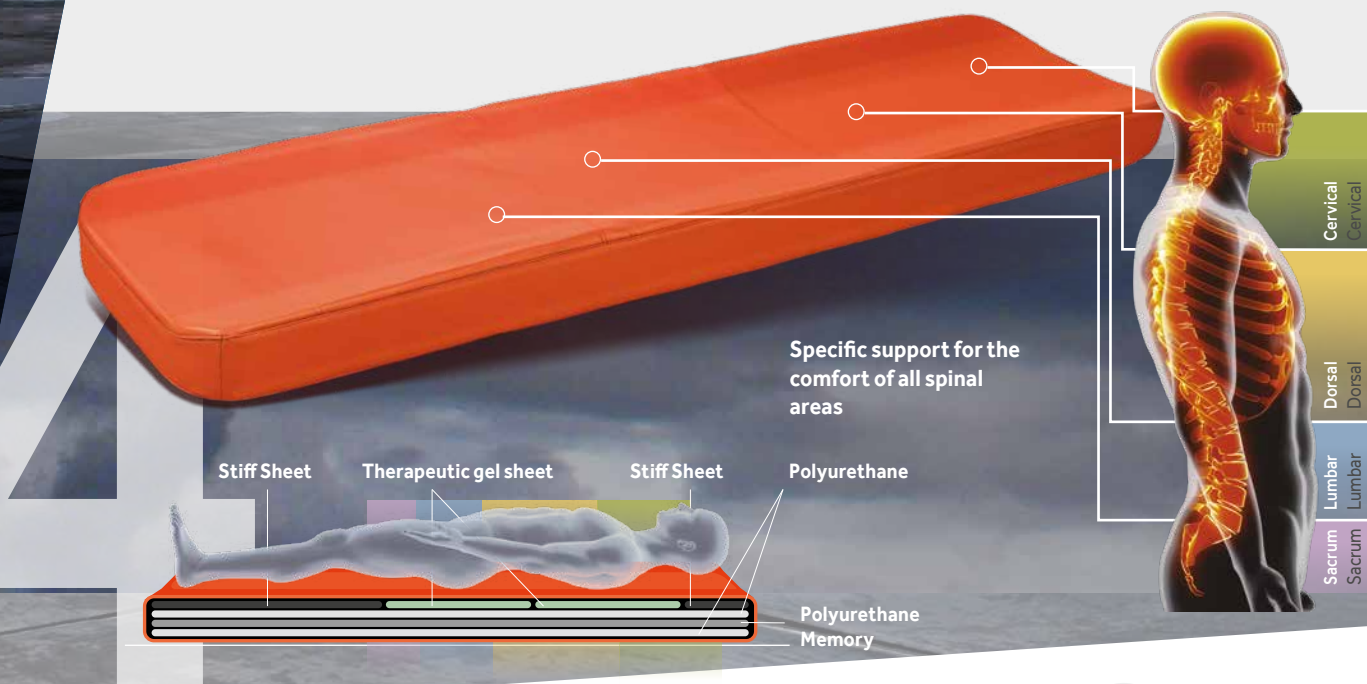

Art. 7018/A

## HI-COM

Orange mattress in slow-recovery expanded polyurethane and therapeutic gel

Mattress in fluid therapeutic gel composed of 3 different layers of expanded polyurethane (1 slow-recovery layer). Equipped with containment wings and two stiff areas: head and feet. The sacral/dorsal area features two therapeutic gel sheets (cm 40x40xH 150) to confer comfort. The three expanded polyurethane areas absorb vibrations caused by transport on the emergency vehicle, while the two therapeutic gel areas support the patient's weight, ensuring maximum comfort. Hand-made in waterproof, fireproof, anti-tear Skai, with double-stitched seams with raised sides. The gel sheets are glued to a unique "pouch" that ensures durability. Fit for any type of ambulance cot.

**Size: cm 179x47x13 – Weight kg 9,7**

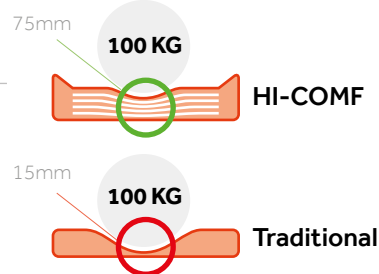

Art. 7018/A-001

## CUSHION

Orange Skai cushion for mattress



Made in slow-recovery expanded polyurethane and coated in fireproof, water-resistant and anti-tear Skai, this cushion fits all of our ambulance cots. Equipped with two rubber bands, allowing positioning in the best position for the patient, this cushion prevents cervical pain and aids blood flow in the area. Comfort is ensured on any kind of transport. **Size: cm 48 x 35 x 7,5**

# AIR-COM

ANTI-BEDSORE MATTRESS FOR LONG-HAUL

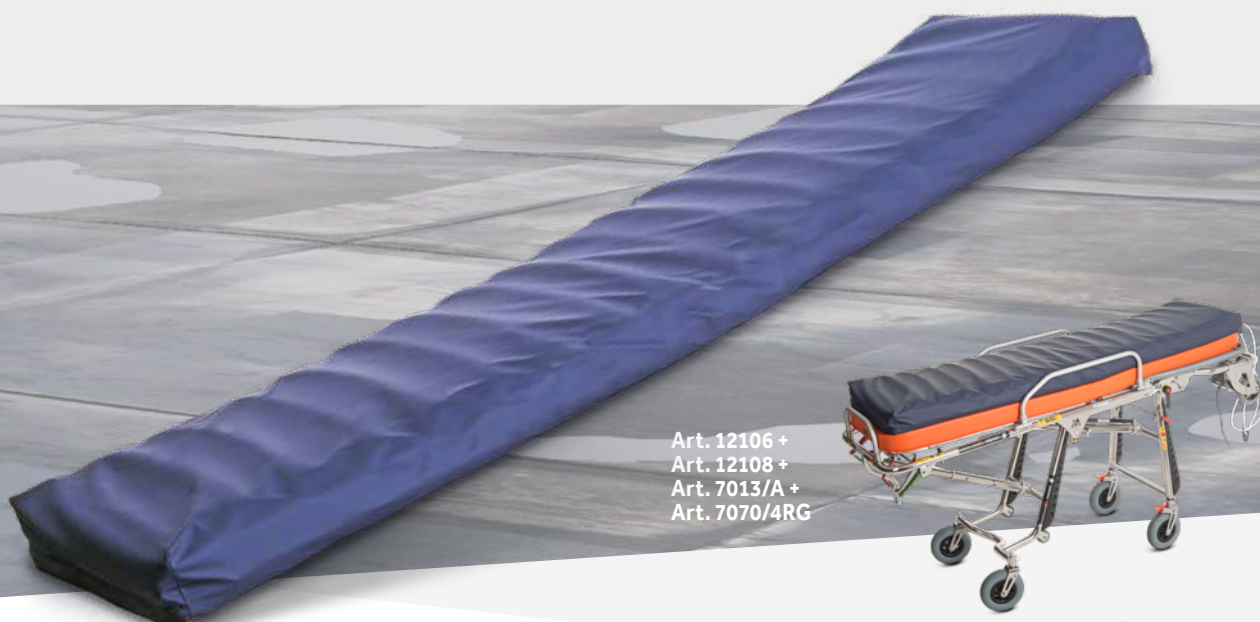

Art. 12106 +  
Art. 12108 +  
Art. 7013/A +  
Art. 7070/4RG

Art. 12106

## AIR-COM

Anti-bedsore segmented mattress for ambulance cots

Overlay mattress in PVC, divided in 18 individual inner tubes. Specifically designed for patients at risk of developing bedsores. AIR-COM fits any mattress for ambulance cots.

The underlying part of the AIR-COM, made in skid-proof fabric, is equipped with 3 eyelets to facilitate anchoring to the cot.

Air compressor with pressure regulator is available (Art. 12108).

**Size: 180 x 46 x 10 cm. Load Capacity: 150 kg.**

Art. 12108

AIR-COM Mattress compressor



Alternate segments diagram of operation

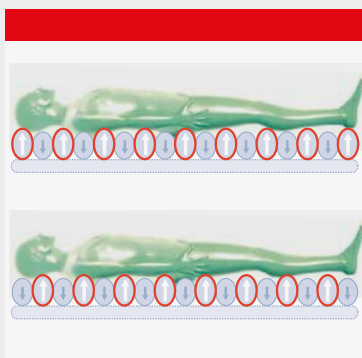



# INFUSION POLES



Art. 12018N

## P-120

Telescopic Infusion Pole for ambulance cots

Foldable Telescopic Infusion pole in aluminium for ambulance cots

Size: H min cm 45 - H max cm 128  
 1<sup>st</sup> step height: cm 70  
 2<sup>nd</sup> step height: cm 98



Art. 12016-E

## EVOX INFUSION POLE

Foldable telescopic infusion pole for EVOX Proof Chair cot

Size:  
 H min cm 43 - H max cm 72,5



Art. 12016-S

## EXTRA INFUSION POLE

Foldable telescopic infusion pole for EXTRA and EXTRA ERGOLIFT Stair Chairs

Size:  
 H min cm 43 - H max cm 72,5



30 mm

Art. 936



46 mm

Art. 936/A



34 mm

Art. 12010

Art. 936 - 936/A - 12010

## INFUSION POLE

Art. 936 for Winner and Frog ambulance cots  
 Art. 936/A for Art. 1510 Proof and Art. 1515 Proof  
 Art. 12010 for Mercury and Gecko ambulance cots

Telescopic infusion pole for ambulance cots. The Pole can be installed anywhere on the cot thanks to a quick anchoring system.

Size: H min cm 47,5 - H max 130,5 cm



Art. 939

## Object Holder

Ambulance cot Object Holder

Support for medical equipment such as defibrillator or monitors to be anchored to the cot's frame. Supplied with straps for the fixing of the medical equipment. Foldable for a better storage.

**Size: cm 34x56x42h fully open, cm 11 depth when closed**



Pediatric

Art. 12050

## INCUBATOR INTERFACE

Extended interface for incubator housing



Pediatric

Art. 12048

## INCUBATOR INTERFACE

10G Interface for incubator housing



Art. 12140

## EVOLUTION

Automatic emergency hammer



Art. 12142

## CLASSIC GLOW

Compact emergency hammer

# PATIENT TRANSFER SYSTEM

Art. 15244

## FOLDABLE SCANGLISS

Foldable transfer board



Foldable transfer board, to be placed underneath a patient and facilitate sliding from cot to bed in complete safety. Split in two (foldable) sections, this device is radiolucent and a-magnetic. Consisting in an inner polyethylene layer, padded in amorphous material (1,5 cm thick) and wrapped in a sliding nylon sheet. SCANGLISS is CE certified according to CEE 93/42 EEC Medical Devices. **Maximum Load: 180 kg.**

**Size 180 x 50 cm**



Art. 15244-001

## COVER

Spare nylon cover for Scangliss



**NEW**  
PRODUCT

Art. 707

## SLASH

Transfer sheet with 6 handles



Slash is the brand new transfer sheet by MeBer. This device facilitates patients' transfer from cot to bed and vice-versa. Equipped with 6 handles, this sheet features a fireproof, water-resistant and anti-tear Nylon. Fit for ambulance cots, the SLASH is easy-to-clean and has a small volume, to ensure easy handling during transfers.

Fit for all ambulance cots. **SLASH does not work as a transport means for injured patients.**

**Loading capacity: kg 160. Weight: kg 1. Size: 188 x 50 cm**



Art. 12098

## BLACK CUSHION

Black cushion with backrest and seat for EXTRA Stair Chairs

Cushion for Stair Chair, designed to ensure maximum comfort during transport and protect the rigid thermoplastics from constant stress. Made in expanded polyurethane (slow-recovery), this cushion is coated in fire-proof, anti-tear Skai fabric. Removable and easy-to-clean. Specifically designed for Extra stair chairs, it can fit any chair in MeBer's range thanks to the Velcro® straps.



Art. 671-001 | Art. 670-002

## COVER

Black breathable dust sheet for Extra Ergolift chairs

Size: cm 55 x 100 x 27 (LxHxD)



# CARRYING BAGS AND CASES



Art. 16102-001

## TOBOGA CASE

Divisible case for Toboga

Size: cm 121x64x24



Art. 12144/N

## CARRYING BAG

Spinal board carrying bag

Spinal board carrying bag with pouch for Spider Fastrap and removable head immobilizer, colour black.

Size: cm 184x43



Art. 16150-001

## LIFTABLE CASE

Liftable case for transport

Designed to facilitate rescue operations, this case for the ERGON scoop stretcher ensures maximum operativity in hostile environment. Equipped with 4 shoulder straps. The ERGON stretcher (disassembled) fits with all of its accessories inside of the case, strongly reducing its volume. The EN566 hook in the centre ensures safe winch operation. **Size: cm 124x32x16**



Art. 16150-002

## STORAGE BAG

Storage bag

Measuring as little as 11 cm in depth, this bag is ideal for ERGON storage, together with its accessories. It was designed for storage purposes or equipped on emergency vehicles. Once opened on the ground, the bag works as an insulating layer, allowing to safely prepare medicines or operate electro-medical devices. **Size: cm 122x47x8**

**NEW**  
PRODUCT

Art. 12084-001

## CARRYING BAG

Bariatric wings carrying bag

Bariatric wings carrying bag (Art. 12086, Art. 12088, Art. 12202 and Art. 12204), black.

Size: cm 136x18x21



Art. 660/CS

## CARRYING BAG

Carrying bag for stretchers Art. 660

Grey nylon bag for Art. 660. Equipped with handles and shoulder strap for transport.

Size art. 660/CS: cm 100 x 16 x 20



Art. 630/CS

## CARRYING BAG

Scoop stretcher carrying bag

Nylon orange carrying bag for scoop stretchers (split in half) with handle.

Size: cm 130x47



Art. 9104-001

## CARRYING BAG

Blue carrying bag for NAXOS vacuum mattress

Size: cm 85xø36

# OBJECT HOLDER



Velcro straps for anchoring

Pouch for documents

Zip Pouch

Art. 12025

## OBJECT HOLDER

Multi-purpose object holder for ambulance cots

Anti-tear nylon object holder, anchorable to any MeBer ambulance cot. Consisting in a closed zip pouch for small items and a bigger pouch for documents, the holder is anchored to the frame of the cot's trolley with Velcro® straps.

**Size: cm 50x37**



ACCESSORIES

# OBJECT HOLDER



Pediatric

Art. 12024

## CASE

Empty case for spider strap and head-immobilizer

Cordura case with handle for spider strap and head-immobilizer. It ensures volume optimization inside of the emergency vehicle and prevents the Velcro® in the head-immobilizer from decaying. Also fit for the storage of Art. 9128 and 9130. SPIDER STRAP AND HEAD-IMMOBILIZER NOT INCLUDED.

**Size: cm 42 x 30 x 11**

Art. 12034

## CASE

Red case for BABY FIX and VACUUM BABY FIX

Red Nylon case with handle and double-zip for the transport of "Baby Fix" and "Vacuum Baby Fix" pediatric devices. Ideal for volume optimization.

BABY FIX and VACUUM BABY FIX NOT INCLUDED.

**Size: cm 41 x 26 x 13**



# OXIMEB

NYLON TANK HOLDER

Inner padding to ensure protection against impact.  
Equipped with handle for transport and lateral  
pouch for tube and mask.

Art. 938

## OXIMEB

Tank holder for  
2 litres tank

Suitable for the housing of 2 litres tank. Thanks to its  
straps system, it can be mounted on a cot's side rail or  
on the backrest of a stair chair.

**Weight: 0,3 kg**



Art. 12054

## OXIMEB MAXI

Tank holder for  
3 litres tank

Suitable for the housing of 3 litres tank. Thanks to its  
straps system, it can be mounted on a cot's side rail  
or on the backrest of a stair chair.

**Weight: 0,3 kg**



# COVER OX

## PROFESSIONAL TANK HOLDERS

Made in high-resistance, anti-tear and easy-to-clean material, these covers are equipped with 2 rubber handles and two knurled plastic bases, allowing both horizontal and vertical operation. They also feature a padded shoulder strap and 2 auxiliary carabiners to facilitate transport. The 6 eyelets placed on the sides constitute a perfect passage for the oxygen

tube. A big central pouch houses a variety of oxygen therapy masks as well as the oxygen extension tube.

Two belt loops with plastic hooks allow anchoring of these covers to any ambulance cot. Built with robust zips, this is a safe, easy-to-clean medical device, designed to last for a long time.

Art. 12072/BR - Art. 12072/BG

### COVER OX 5

Professional tank holder  
for 5 litres tank

Professional tank holder for 5 litres tank. Blue with yellow profiles and yellow Logo or blue with red profiles and orange Logo.

Size: (LxHxD) 67 x 22 x 24 cm. Weight: 1,2 kg



Art. 12070/BG - Art. 12070/BR

### COVER OX 2-3

Professional tank holder  
for 2 or 3 litres tank

Professional tank holder for 2 or 3 litres tank. Blue with yellow profiles and yellow Logo or blue with red profiles and orange Logo.

Size: (LxHxD) 60 x 22 x 21 cm. Weight: 1,1 kg



# IMMOBILIZATION

# 5

The management of an injured patient is always a critical phase of all emergency operations, especially the immobilization process. Thanks to high quality products, the operator may ensure a quick and efficient stabilization, avoiding further worsening of a patient's condition. Completing the classic Galaxy spinal board range, ever appreciated for its simplicity and build quality, many innovative products complete MeBer's range of immobilization devices, especially to cover all pediatric necessities.

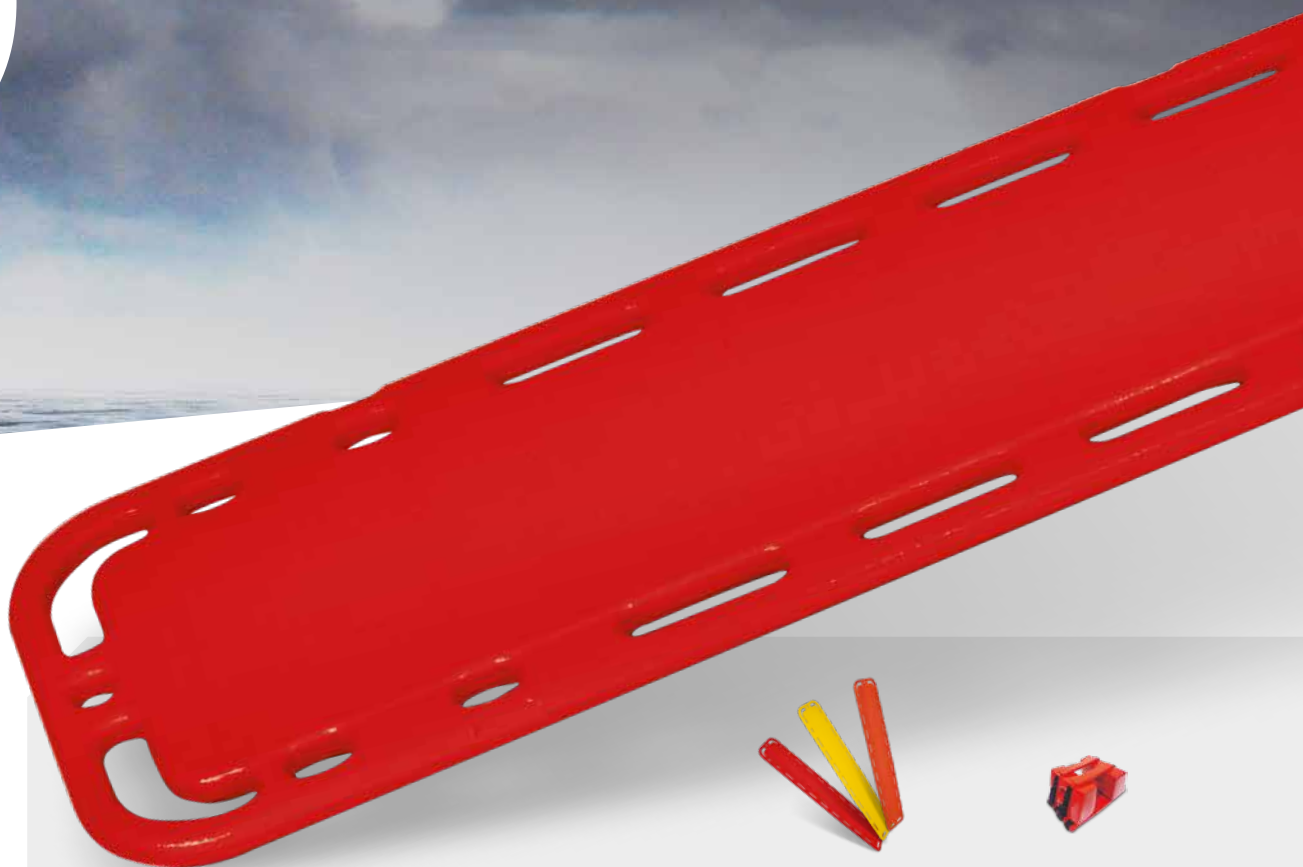

Spinal boards

Head immobilization

# IMMOBILIZATION



Discover MeBer products on-lineShoot the QR code with your tablet or smartphone to land on the dedicated page on the website. You might be required to install a free application to navigate.

Alternatively, go to:  
<https://www.meber.it/en/products/immobilization.aspx>

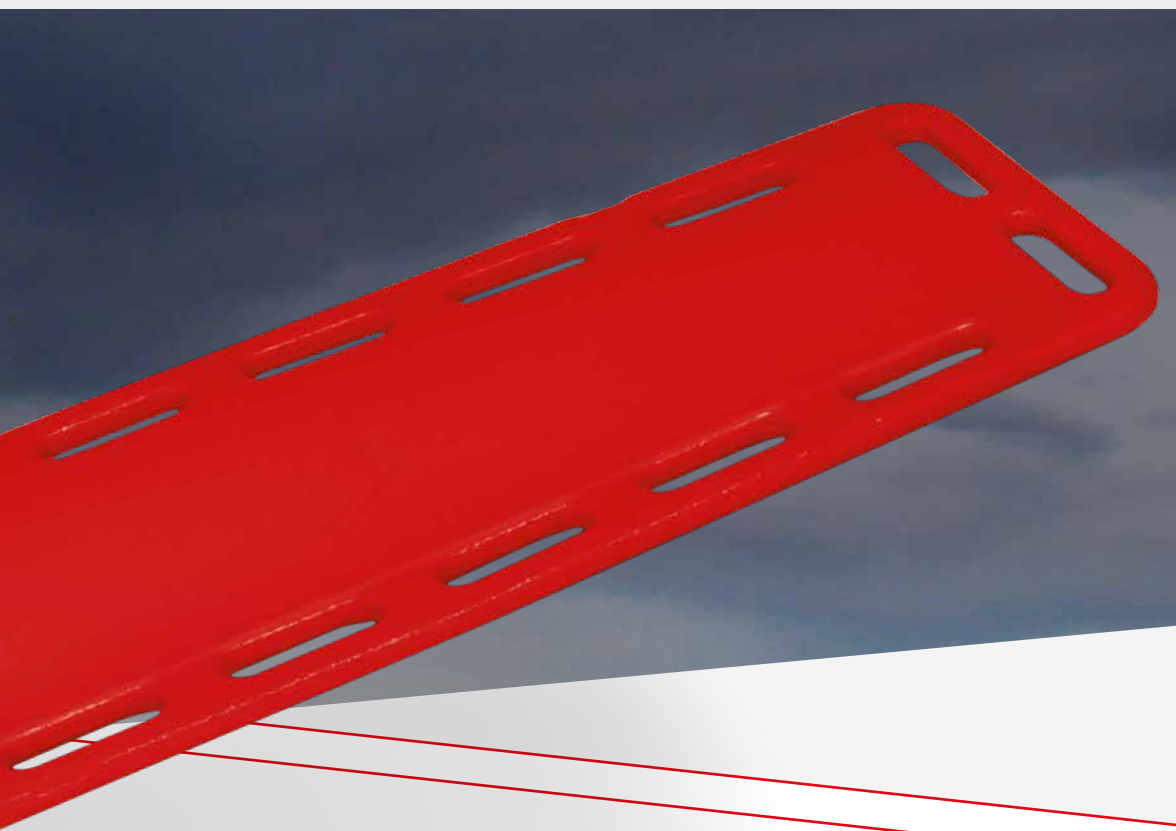

**Vacuum mattresses**



**Splints**



**Cervical Collars**



**Spinal immobilizers**

# GALAXY

SPINAL BOARDS FOR ADULTS

5



Art. 9012  
Orange

Art. 9010  
Yellow

Art. 9016  
Red



Trauma

Art. 9010 - Art. 9012 - Art. 9016

## GALAXY

Yellow, orange and red Spinal Boards

Spinal boards in high-resistance plastic material. The GALAXY was designed paying special attention to the daily complications occurring in rescue operations. For a fast and practical fastening of the head immobilizer, the board features 4 eyelets on the top, as well as a hollow area on the support area of the board. This ensures perfect immobilization and avoids damage to the straps during ambulance transfers. The board features 20 handles for transport and is supplied with 3 quick-release straps (Art. 605/MEB). X-Ray translucent.

**Device certified according to the European harmonized safety standards UNI EN 1865 – UNI EN 1789.**

Accessories



Art. 12144/N  
Spinal board  
carrying case



**Art. 690**  
**SPIDER**  
**Immobilization strap**  
**system for spinal**  
**board**

This strap system ensures perfect immobilization of the patient. Thanks to its transversal sliding straps and VELCRO fastening, it suits any spinal board as well as any patient.



**Art. 629**  
**JELLY**  
**Standard orange head**  
**immobilizer for spinal**  
**board**

Adjustable to any spinal board model, this head immobilizer is made up of expanded close-cells material and coated in vinyl.

Under X-rays, the Galaxy boards can be spotted as a longitudinal shadow, allowing the performance of radiographic examinations without moving the patient. The positioning of the internal reinforcements of the boards was designed not to hinder the identification of organ injuries.

| Art.     | Colour | Length<br>Adjustable height | Width | Thickness | Weight | Load   |
|----------|--------|-----------------------------|-------|-----------|--------|--------|
| 9010     |        |                             |       |           |        |        |
| 9012     |        |                             |       |           |        |        |
| 9016     |        | 183 cm                      | 41 cm | 5 cm      | 5,5 kg | 150 kg |
| 9016/CRI |        |                             |       |           |        |        |

**High level radiographic**  
**transparency**

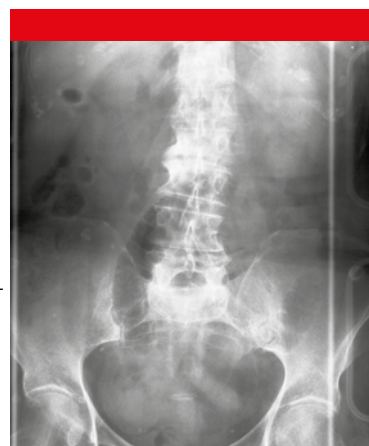

# DUCK

PEDIATRIC SPINAL BOARDS



Art. 9022  
Yellow

Art. 9024  
Orange



Pediatric





Trauma

Art. 9022 - Art. 9024

## DUCK

Pediatric spinal board, orange and yellow

Designed for the immobilization and transport of pediatric patients **up to 120 cm**, made in high resistance plastic material. The DUCK was designed paying special attention to the daily complications occurring in rescue operations. For a fast and practical fastening of the head immobilizer, the board features 4 eyelets on the top, as well as a hollow area on the support area of the board. This ensures perfect immobilization and avoids damage to the straps during ambulance transfers. The board features 10 handles for transport. The DUCK allows the performance of radiographic examinations with X-Rays and can be supplied in 2 colours: yellow and orange. The straps are not included.

| Art. | Colour  | Length<br>Adjustable height | Width | Thickness | Weight | Load   |
|------|---|-----------------------------|-------|-----------|--------|--------|
| 9022 |  | 125 cm                      | 41 cm | 5 cm      | 3,7 kg | 100 kg |
| 9024 |  |                             |       |           |        |        |



Art. 692

## SPIDER BABY Pediatric Spinal Board immobilization straps

Strap system for the immobilization of a pediatric patient on a DUCK spinal board. Thanks to the transversal sliding straps, this device can be easily adjusted to any patient.



Pediatric



Trauma



See page 105  
ACCESSORIES

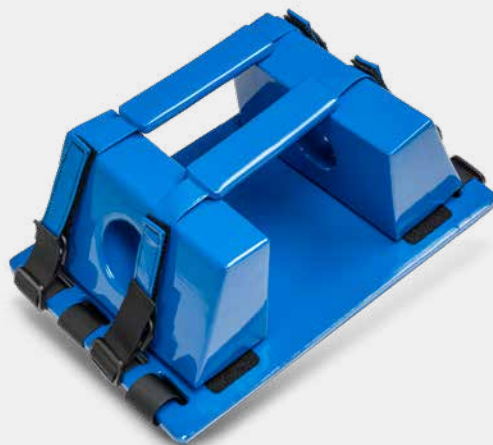

Art. 627

## KIDS Pediatric padded head immobilizer

Padded head immobilizer for pediatric spinal boards, made in close-cells expanded material, coated in vinyl.



Pediatric



Trauma





# HEAD IMMobilIZER

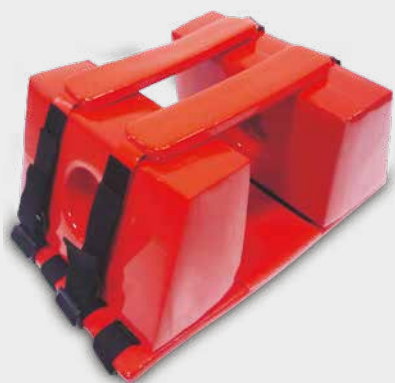

Art. 629

## JELLY

Standard orange head immobilizer for spinal board

Adjustable to any spinal board model, this head immobilizer is made up of expanded close-cells material and coated in vinyl.

Art. 627

## KIDS

Pediatric padded head immobilizer

Padded head immobilizer for pediatric spinal boards, made in close-cells expanded material, coated in vinyl.



Pediatric



Art. 9150

## X-LOCK

Ergonomic head immobilizer for ERGON stretcher

Innovative head immobilizer, made up of a single element, integrated straps, ensuring a fast fastening of the head to the stretcher. Made in laminated polyester and bi-density expanded polyurethane.



Trauma



Art. 670-001

Orange/black head immobilizer for Extra Stair Chair



Trauma



Art. 624

DOUBLE Head immobilizer for scoop stretchers



Trauma



IMMOBILIZATION

# SPINAL BOARDS

with pins

Art. 9040  
Yellow

Art. 9042  
Orange



Accessories



Art. 574

2-pieces blue belt with carabiners

Art. 9040 - Art. 9042

## GALAXY-P

Yellow and orange spinal board with pins

Spinal board with the same features as "Galaxy" Art. 9010 and 9012. Equipped with 10 plastic pins for a quick-fastening of restrain systems (with carabiners). Supplied with 3 belts (Art. 605/MEB).

| Art. | Colour | Length<br>Adjustable height | Width | Thickness | Weight | Load   |
|------|--------|-----------------------------|-------|-----------|--------|--------|
| 9040 | ■      | 183 cm                      | 41 cm | 5 cm      | 5,8 kg | 150 kg |
| 9042 | ■      |                             |       |           |        |        |

Art. 9050

## NILIX

Yellow standard spinal board with pins

Basic spinal board in high density plastic material, equipped with 8 pins.  
**Belts are not included.**

| Art. | Length | Width | Thickness | Weight | Load   |
|------|--------|-------|-----------|--------|--------|
| 9050 | 183 cm | 40 cm | 5 cm      | 6,5 kg | 150 kg |



IMMOBILIZATION

# VACUUM MATTRESSES



Art. 9104-001

Carrying bag for "NAXOS",  
single-chamber vacuum  
mattress

Accessories



Trauma

Art. 9104

## NAXOS

Single chamber vacuum mattress

Single chamber vacuum mattress, blue and orange.

**Weight: 6 kg - Size: cm 200x80**



Outer  
view

IMMOBILIZATION

# VACUUM MATTRESSES



Internal view



Trauma

Art. 9114

## **CHESTERFIELD**

Vacuum mattress with independent chambers with central welding

CHESTERFIELD vacuum mattress with independent chambers with central welding.  
Usable with X-ray, CT and MRI..

**Size: cm 210 x 100 - Weight: kg 7,8.**

IMMOBILIZATION

# VACUUM MATTRESSES



Art. 894-001

Intake valve  
for vacuum  
mattresses  
and splints.



Art. 890-001

Carrying case for  
vacuum mattress.  
Size: 93x63x18 cm



Trauma

Art. 894

## SNAKE

Independent chambers vacuum mattress

Vacuum mattress with 14 independent chambers, for a quick and precise immobilization. Extremely light and resistant, this model features 8 ergonomic handles and restraining belts. Ensuring perfect containment, the "Snake" is a truly unique device. Working conditions between -30°C and +70°C. A lasting vacuum and no deformation, together with the UNI EN 1865 certification, top off an excellent device. Compatible with X-Rays, CT and MRI.

**Weight 8 kg - Size cm 210x100**

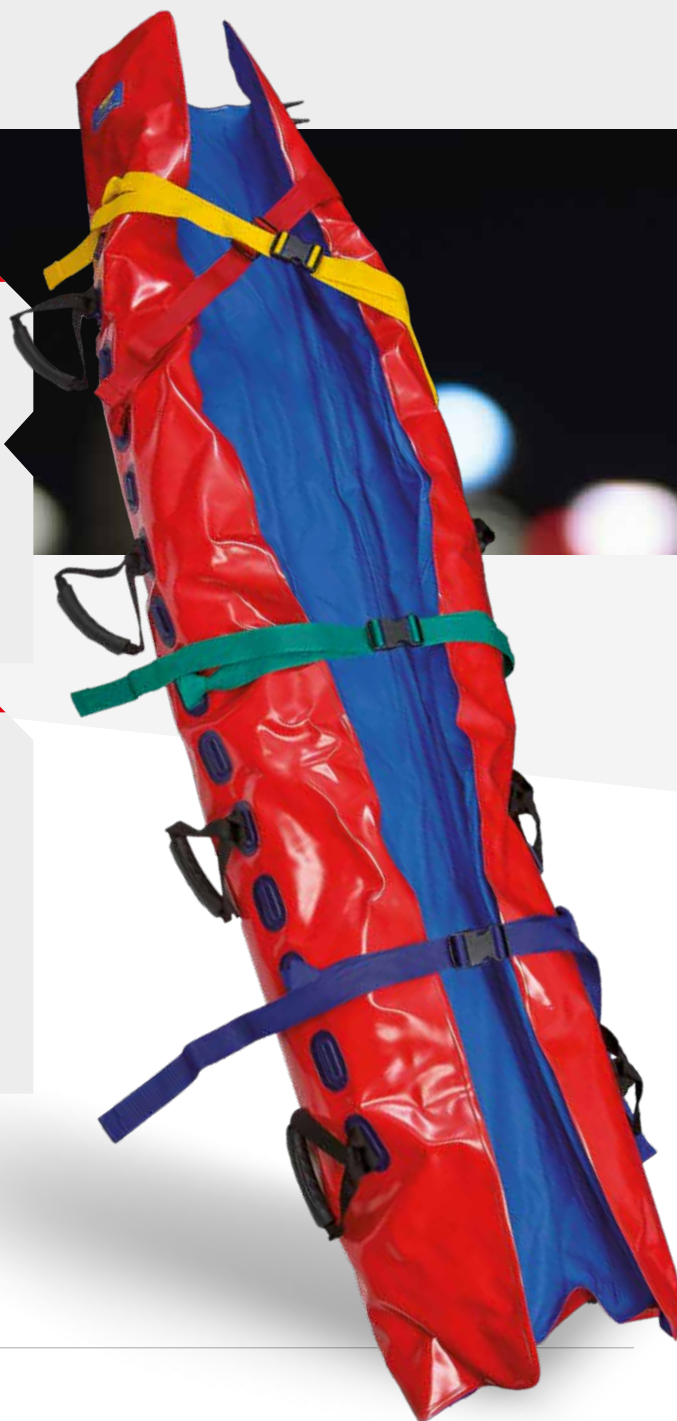



Trauma

Art. 895

## SNAKE PLUS

Independent chambers vacuum mattress with head immobilizer

Mattress with integrated head immobilizer for a quick head immobilization. Made of polyurethane, treated with flame retardant, certified according to the European harmonized safety standards UNI EN 1865. 14 independent chambers for a safe and precise immobilization. Working conditions between -30°C and +70°C. Extremely light and sturdy, equipped with 8 ergonomic padded handles and safety straps for an excellent patient containment. Compatible with X-Rays, CT and MRI.

**Weight 8,3 kg - Size cm 210x100**

Accessories



Art. 888

### Aluminium suction pump

Aluminium suction pump for vacuum mattresses with foot support.



Art. 896/DF

### ABS suction pump

ABS suction pump for vacuum mattresses, for inflation or deflation. Equipped with junctions.



IMMOBILIZATION

# VACUUM MATTRESSES



Art. 894-001

Intake valve for vacuum mattresses and splints.



Art. 9100-001

Carrying case for pediatric vacuum mattress.  
Size: 72x52x16 cm



Pediatric Trauma

Art. 9100

## BUNNY

Pediatric vacuum mattress with independent chambers

Polyurethane mattress with flame retardant treatment, 14 independent chambers for a safe and precise immobilization. Working conditions between -30°C and +70°C. Extremely light and sturdy, equipped with 4 ergonomic padded handles and safety straps for an excellent patient containment. Compatible with X-Rays, CT and MRI.

**Weight 3 kg - Size cm 120x70**





Pediatric



Trauma

**Art. 9102**

## **BUNNY PLUS**

**Pediatric vacuum mattress with independent chambers and head immobilizer**

Polyurethane mattress with flame retardant treatment, 14 independent chambers for a safe and precise immobilization. Working conditions between -30°C and +70°C. Extremely light and sturdy, equipped with 4 ergonomic padded handles and safety straps for an excellent patient containment. Compatible with X-Rays, CT and MRI.

**Weight 3,5 kg - Size cm 120x70**

Accessories



**Art. 888**

### **Aluminium suction pump**

Aluminium suction pump for vacuum mattresses with foot support.



**Art. 896/DF**

### **ABS suction pump**

ABS suction pump for vacuum mattresses, for inflation or deflation. Equipped with junctions





IMMOBILIZATION

# VACUUM MATTRESSES



Trauma

Art. 894/SNOW

## SNAKE SNOW

Independent chambers vacuum mattress with anti-sliding features

Vacuum mattress with 14 independent chambers, for a quick and precise immobilization. Equipped with anti-sliding features for rescue in snow-capped conditions. Extremely light and resistant, this model features 8 ergonomic handles and restraining belts. Ensuring perfect containment, the "Snake" is a truly unique device. Working conditions between -30°C and +70°C. A lasting vacuum and no deformation, together with the UNI EN 1865 certification, top off an excellent device. Compatible with X-Rays, CT and MRI. **Size: cm 210x100. Weight: 8,9 kg**

Art. 888

### Aluminium suction pump

Aluminium suction pump for vacuum mattresses with foot support.



Art. 896/DF

### ABS suction pump

ABS suction pump for vacuum mattresses, for inflation or deflation. Equipped with junctions.



Accessories





Trauma

Art. 891

## FLAKE

Independent chambers vacuum mattress

3-chambers vacuum mattress, for a quick and precise immobilization. Extremely light and resistant, this model features 8 ergonomic handles and restraining belts. Ensuring perfect containment, the "FLAKE" is a truly unique device. Long lasting vacuum and no deformation complete this model. **Weight 6,7 kg - Size cm 200x90**

Accessories

Art. 888

### Aluminium suction pump

Aluminium suction pump for vacuum mattresses with foot support.



Art. 896/DF

### ABS suction pump

ABS suction pump for vacuum mattresses, for inflation or deflation. Equipped with junctions.



Art. 894-001

Intake valve for vacuum mattresses and splints.

# BABY FIX

PEDIATRIC RESTRAINT SYSTEM WITH VACUUM MATTRESS

Art. 9130

## MEBER BABY FIX

**Restraint system with straps for ambulance transport**

MeBer Baby Fix is a universal pediatric transport device, adjustable to any stretcher, with 6 straps. Suitable for infants and children up to 130 cm and 35 KG, this device ensures a safe transport thanks to its 5 anchor points. Supplied with case Art. 12034. Certified UNI EN 1789.

**Length: 74 cm; Head Width: 39 cm; Feet width: 20 cm**



Pediatric



Art. 9128

## MEBER VACUUM BABY FIX

**Small vacuum mattress for pediatric restraint system with straps (ambulance transport)**

MeBer Vacuum Baby Fix is a vacuum mattress, to be combined with Art. 9130. Extremely light and resistant. Thanks to its safety straps and to a precise and quick containment, this 9128 is a truly unique device. Certified UNI EN 1789, radiolucent, a-magnetic.

**Size: 79 x 45 cm**



Pediatric



Trauma

**MeBer Exclusive**



Accessories



Pediatric

Art. 12034

**Red Case for BABY FIX and VACUUM BABY FIX**

# RIGID SPLINTS



**Art. 430**  
Rigid splint set with carrying case



**Art. 425**  
Adult rigid splint for the lower limbs



**Art. 427**  
Rigid splint for upper limbs (adults) / lower limbs (pediatric patients)



Trauma

**Art. 425 - Art. 427 - Art. 430**

## ARCOS

### Rigid splints

Rigid splints in fire-proof and water-resistant PVC. This device ensures a correct limb immobilization. Equipped with 4 VELCRO straps (different lengths), ensuring a safe and quick application.

This model is shaped for a firm lacing to ankles and upper leg and is equipped with integrated foot support. Radiolucent.

**Available sizes:**

**Adult arm / pediatric leg: length 52 cm – base 9 cm**

**Adult leg: length 74 cm – base 13 cm**

# SPLINTS



**Art. 880**



**Art. 884**



**Art. 882**



**Art. 886**

**Art. 880 - Art. 882 - Art. 884 - Art. 886**



Trauma

## HALLEY

### Vacuum Splints

Made in high quality materials, the HALLEY ensures a perfect immobilization of the lower and upper limbs by means of vacuum suction. This device is equipped with an external intake valve to avoid annoyance to the patient. This device can be ordered as an individual unit or as a set. The set includes one arm vacuum splint, one leg vacuum splint, one forearm vacuum splint, a small suction pump and a nylon carrying case. All items are radiolucent.

**Accessories**



**Art. 889**

**Small aluminium suction pump**



**Art. 894-001**

**Intake valve for vacuum mattresses and splints.**



**Art. 880 Leg vacuum splint**

**Art. 882 Arm vacuum splint**

**Art. 884 Forearm vacuum splint**

**Art. 886 3 splints set with carrying case and suction pump**

# SPLINTS



Art. 9160

## VACUUM SPLINT

**Leg vacuum splint with 16 independent chambers**

For a quick and precise immobilization. Equipped with internal valve and junctions.

**Compatible with X-Rays, CT and MRI.**



Art. 9162

## VACUUM SPLINT

**Arm vacuum splint with 14 independent chambers**

For a quick and precise immobilization. Equipped with internal valve and junctions.

**Compatible with X-Rays, CT and MRI.**

Art. 9140 - Art. 9142 - Art. 9144



Trauma

## TRACTION SPLINT

**Traction splint**

**Art. 9140 - Traction splint set for adult and pediatric application – with case**

Splint set for femoral traction, supplied with case. Equipped with 2 immobilization devices, adult and pediatric.

**Art. 9142 - Adult traction splint with case**

The device ensures a correct and aligned traction, thus reducing pain and preventing further injury during transport.

**Art. 9144 - Pediatric traction splint with case**

The device ensures a correct and aligned traction, thus reducing pain and preventing further injury during transport.



Pediatric



# SPLINTS



**Art. 417**



320 mm

**Art. 412**



400 mm

**Art. 410**



**Art. 415**



560 mm

**Art. 407**



610 mm

**Art. 405**

600 mm

Art. 405 - Art. 407 - Art. 410 - Art. 412 - Art. 415 - Art. 417

## NEOFIX

### Neoprene splint

Rigid flexible neoprene splints, equipped with an inner aluminium sheet to ensure perfect adaptation on a case by case basis. The aluminium sheet can be removed for cleaning. The neoprene material ensures constant body temperature and perfect shaping of the splint, as well as a being easily cleanable. There are 5 available sizes: leg, arm, forearm, wrist and ankle/elbow.



Trauma

**Art. 405 Leg splint**

**Art. 407 Arm splint**

**Art. 410 Forearm splint**

**Art. 412 Wrist splint**

**Art. 415 Ankle/Elbow splint**

**Art. 417 Splint set (5 units) with carrying case**



Trauma

**Art. 722**

## AIR SPLINT

### Set of 6 pneumatic splints with pump and carrying case

Plastic pneumatic splints including: carrying case, pump, hand/wrist splint, arm splint, forearm splint, foot splint and short leg splint, long leg splint



IMMOBILIZATION

# CERVICAL COLLARS



Trauma

Art. 836

## **PATRIOT**

Adjustable cervical collar



Adjustable cervical collar with 4 heights. This device was designed to fit a variety of immobilization needs and it was specifically destined to medical emergencies. It is equipped with a pre-moulded chin support, locking clips, rear ventilation panel and large trachea opening. The PATRIOT cervical collar comes in high-density polyethylene and foam padding. The flat one-piece design enables efficient storage. X-Ray lucent and easy to clean.



Trauma



Pediatric

Art. 837

## **PATRIOT BABY**

Adjustable pediatric cervical collar



Sharing the same features of its adult version, the PATRIOT BABY is an adjustable pediatric cervical collar with 3 different heights.



IMMOBILIZATION

# CERVICAL COLLARS



## GEMINI

### Rigid 2 pcs cervical collar

The GEMINI cervical collar is a highly professional and indispensable device for rescue operators. Composed by 2 pieces, it fits in the front and rear parts of the neck, ensuring a perfect rachis immobilization. Equipped with a central hole for tracheotomy, it is easily adjustable thanks to the straps. Made in printed polyethylene, the GEMINI comes in various colourings to properly choose size. Internal covering in washable E.V.A., fixed with plastic rivets. Available in 6 different sizes.

| Art. | Size        | Set                                     | Pieces per pack |           |
|------|-------------|---|-----------------|-----------|
| 9213 | Set 3 sizes | 9204 + 9206 + 9208                      | 3               | With case |
| 9214 | Set 4 sizes | 9204 + 9206 + 9208 + 9210               | 4               | With case |
| 9216 | Set 6 sizes | 9200 + 9202 + 9204 + 9206 + 9208 + 9210 | 6               | With case |



## ARTIS

### Rigid cervical collar in 1 piece

1 piece cervical collar equipped with a central hole for tracheotomy, it is easily adjustable thanks to the straps. Made in printed polyethylene, the ARTIS comes in various colourings to properly choose size. Internal covering in washable E.V.A., fixed with plastic rivets. Available in 6 different sizes.

| Art. | Size        | Set                                     | Pieces per pack |           |
|------|-------------|---|-----------------|-----------|
| 9233 | Set 3 sizes | 9224 + 9226 + 9228                      | 3               | With case |
| 9234 | Set 4 sizes | 9220 + 9224 + 9226 + 9228               | 4               | With case |
| 9236 | Set 6 sizes | 9220 + 9222 + 9224 + 9226 + 9228 + 9230 | 6               | With case |



**Art. 842**  
**PEDIATRIC**  
Pediatric

**Art. 840**  
**INFANT**  
Pediatric

**Art. 846**  
**STANDARD**

**Art. 848**  
**MEDIUM**

**Art. 844**  
**STOUT**

**Art. 850**  
**TALL**

## ANTARES

### Rigid cervical collar in 2 pieces

The ANTARES cervical collar is a highly professional and indispensable device for rescue operators. Composed by 2 pieces, it fits in the front and rear parts of the neck, ensuring a perfect rachis immobilization. Equipped with a central hole for tracheotomy, it is easily adjustable thanks to the straps. Made in transparent polyethylene, the ANTARES comes in various colourings to properly choose size. Internal covering in washable E.V.A., fixed with plastic rivets. Available in 6 different sizes.

| Art. | Size        | Set                               | Pieces per pack |           |
|------|-------------|-----------------------------------|-----------------|-----------|
| 853  | Set 3 sizes | 844 + 846 + 848                   | 3               | With case |
| 854  | Set 4 sizes | 842 + 844 + 846 + 848             | 4               | With case |
| 856  | Set 6 sizes | 840 + 842 + 844 + 846 + 848 + 850 | 6               | With case |

## SIRIUS

### Rigid cervical collar in 1 piece

Rigid cervical collar in 1 piece made with transparent polyethylene with E.V.A. washable inner lining fixed by plastic rivets. Adjustable rip-off fastening which different colours indicate the various sizes. Central hole for tracheotomy. Available in 6 different sizes.



**Art. 862**  
**PEDIATRIC**  
Pediatric

**Art. 860**  
**INFANT**  
Pediatric

**Art. 866**  
**STANDARD**

**Art. 868**  
**MEDIUM**

**Art. 864**  
**STOUT**

**Art. 870**  
**TALL**

| Art. | Size        | Set                               | Pieces per pack |           |
|------|-------------|-----------------------------------|-----------------|-----------|
| 873  | Set 3 sizes | 864 + 866 + 868                   | 3               | With case |
| 874  | Set 4 sizes | 862 + 864 + 866 + 868             | 4               | With case |
| 876  | Set 6 sizes | 860 + 862 + 864 + 866 + 868 + 870 | 6               | With case |

IMMOBILIZATION

## EXTRICATION



Trauma



Art. 899

**MED****Spinal immobilizer**

The MED spinal immobilizer is ideal for the immobilization and extrication of a patient under critical conditions, such as road accidents. Thanks to its enveloping shape and structure, it ensures blocking of vertical and lateral movements of the head and spinal column, to minimize potential trauma during transfer. Equipped with coloured straps and belts, a padded cushion and two straps for forehead and chin. Supplied with carrying case. **Weight: 2,9 kg**



Trauma

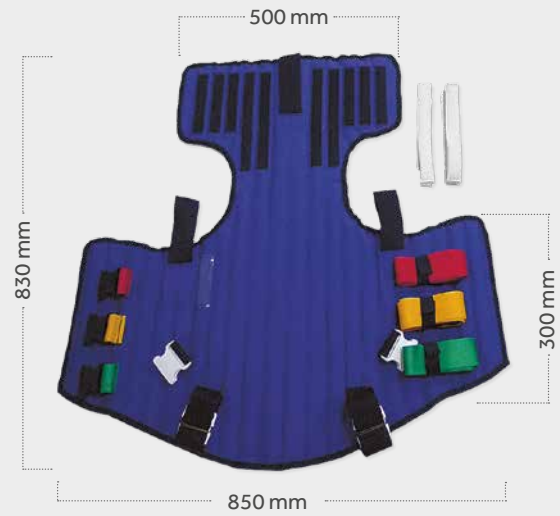

Art. 9124/B

## SPINAL IMMOBILIZER

Standard blue spinal immobilizer

Essential device for a safe patient immobilization and extrication. Made of vinyl-coated nylon. Equipped with padded cushion, 2 straps and a carrying bag. **Weight: 2,9 kg**



Trauma



Pediatric



Art. 9120

## MED PED

Pediatric spinal immobilizer

The "MED PED" spinal immobilizer is ideal for the immobilization and extrication of a patient under critical conditions, such as road accidents. Thanks to its enveloping shape and structure, it ensures blocking of vertical and lateral movements of the head and spinal column, to minimize potential trauma during transfer. Equipped with coloured straps and belts, a padded cushion and two straps for forehead and chin. Supplied with carrying case. **Weight: 1,4 kg**

# DIAGNOSTIC

6

The diagnostics line from MeBer includes traditional devices such as phonendoscopes and sphygmomanometers as well as multiparameter monitors, pulse oximeters and TecnoHeart Automated Defibrillators. Beyond the obvious relevance in terms of vital signs' monitoring or, when it comes to defibrillators, the life-saving role they play, the diagnostics line is a crucial aspect for the patient's perception of an operator's degree of professionalism



Sphygmomanometers



Stethophonendoscopes



Defibrillators



Pulse Oximeters

S



Discover MeBer products on-line. Shoot the QR code with your tablet or smartphone to land on the dedicated page on the website. You might be required to install a free application to navigate.

Alternatively, go to:  
<https://www.meber.it/en/products/diagnostic.aspx>



DIAGNOSTICS

# SPHYGMOMANOMETERS

Art. 8006

## SPHYGMOMANOMETER

Aneroid sphygmomanometer

Manometer, range 0-300 mm Hg. Accuracy +/- 3 mm Hg. Adult Velcro® cuff and metal ring. Supplied with carrying case.



Art. 8008

## SPHYGMOMANOMETER

One hand aneroid sphygmomanometer

Antishock ABS case manometer Ø 60 mm. Range 0-300 mm Hg. Accuracy +/- 3 mm Hg. Manometer with NON STOP PIN. Easy left-hand or right-hand operation. Adult nylon cuff with Velcro® strap and metal ring. Single corrugated latex ball for improved intake and chrome-plated vent valve. Supplied with carrying case with zip.



Art. 8012

## SPHYGMOMANOMETER

Red aneroid one hand sphygmomanometer (Plus)

Ø 48 mm. Precision sphygmomanometer with protective ring and extremely sensitive deflation valve. Anodised aluminium.





Art. 8014

## SPHYGMOMANOMETER

Compact aneroid sphygmomanometer

This handmade sphygmomanometer features a high quality finish. It features state-of-the-art components and the highest technological solutions. The German movement follows the highest quality standards. The Polycarbonate glass is alcohol- and stress-proof. The drain valve is easy to activate and extremely sensitive. Equipped with natural rubber bladder. The nylon cuff is resistant and anti-allergic. The manometer, fixed on the cuff, is highly resistant to falls or casual blows. Made in Italy according to the EN 1060-1 and EN 1060-2.



Art. 8004

## SPHYGMOMANOMETER

Coloured aneroid sphygmomanometer with case

Range 0-300 mm Hg. Accuracy +/- 3 mm Hg. Manometer with NON-STOP PIN. Adult nylon cuff with Velcro® strap and metal ring. Single corrugated latex ball for improved intake and chrome-plated vent valve. Supplied with carrying case with zip.



Pediatric

Art. 8009

## SPHYGMOMANOMETER

Shock proof aneroid sphygmomanometer for children

Manometer range 0-300 mm/Hg. Accuracy +/- 3 mm/Hg. Light and sturdy. Pediatric nylon cuff with Velcro® strap and metal ring. Supplied with carrying case with zip.



Pediatric

Art. 8011

## SPHYGMOMANOMETER

Neonatal and pediatric sphygmomanometer SET

Sphygmomanometer set equipped with 1 neonatal cuff and 1 pediatric cuff, supplied with coloured carrying case.



# WALL-MOUNT SPHYGMOMANOMETERS

6



Art. 1740

## SPHYGMOMANOMETER

### Rotating wall-mount aneroid sphygmomanometer

Round sphygmomanometer. Easy to read, it is ideal for ambulances and clinics. 65° rotation in both directions, roomy cuff basket for storage of accessories, coiled tube extendible to a length of 3 m, single latex ball for improved intake and chrome-plated vent valve, dial-plate diam. 147 mm. Specially tempered copper-beryllium diaphragm. Calibrated nylon cuff with Velcro® strap and 2-tube latex bladder.

Accessories



**Art. 1740-001**

Pediatric cuff for wall-mount aneroid sphygmomanometer Art. 1740



Pediatric



Cuff

### Adult cuffs



**Art. 8140**  
1 tube



**Art. 8141**  
2 tubes

### Pediatric cuffs



**Art. 8142**  
1 tube



**Art. 8143**  
2 tubes



Pediatric



Pediatric

# AUTOMATIC BLOOD PRESSURE MONITOR



Art. 8534

## B1 CLASSIC

### Automatic blood pressure monitor with adult cuff

Easy to use, accurate and reliable medical device for blood pressure monitoring. This device complies with the requirements of the Medical Device Directive 93/42/EEC. and offers different cuff sizes, depending on the circumference of the patient's arm. Optional «Easy» preformed cuffs are also available for a better fitting and comfort.

|                       |  |
|-----------------------|--|
| Dimensions            | 124 x 92 x 61 mm   |
| Weight                | 251 g  |
| Storage Temperature   | -20/+55 °C - -4/+131 °F 15-95% relative max. humidity              |
| Operating temperature | 10 - 40 °C / 50 - 104 °F 15-95% relative max. humidity             |
| Measurement range     | 20 - 280 mmHg – blood pressure / 40 - 200 beats per minute – pulse |
| Memories              | last 30 measurements   |
| Voltage source        | 4 x batteries 1,5 Volt; size AAA                                   |

#### Art. 8534-001

S-SIZE Pediatric cuff  
17-22 cm.



Pediatric



#### Art. 8534-002

M-L SIZE Standard cuff  
22-42 cm



#### Art. 8534-003

L-XL SIZE Obese cuff  
32-52 cm



Bariatric



#### Art. 8536

220V power cable for "B1 CLASSIC" blood pressure monitor

Accessories



# PHONENDOSCOPES, STETHOPHONENDOSCOPES and **INFRARED THERMOMETER**



Art. 8030/B

## RAPPAPORT

### Blue stethophonendoscope

Professional stethophonendoscope. Thanks to its accessories, it is possible to perform different kinds of auscultation. Equipped with twin tube, metal head, rotating pavilions for the its double function, 3 cuffs in different sizes, 2 smooth olives, 2 rigid olives and 2 membranes.

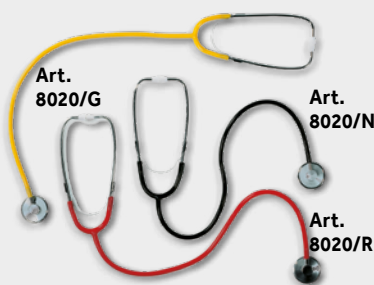

Art. 8020

## PHONENDSCOPE

### Flat phonendoscope

Flat phonendoscope with anodized stamped and lathed aluminium head diameter 46 mm. Threaded metal ring for membrane blocking. Metal chromium plated binaural, length 150 mm. Y rubber tube in one piece, diameter 5 mm. length 60 cm. Single carton box. Available in 3 different colours.

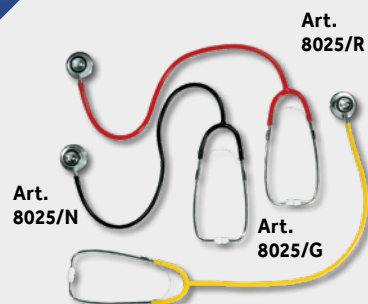

Art. 8025

## STETHOPHONENDSCOPE

### Flat stethophonendoscope

Stethophonendoscope with 47/31 mm head diameter. Aluminium anodized head, Chromium plated metal binaural, Y rubber tube in one piece. Rotating piper-fitting for both functions. Available in 3 different colours.



**NEW PRODUCT**

Art. 8377

## INFRARED

### Infrared thermometer

Infrared thermometer for a contactless, quick, precise and reliable body temperature measurement. Easy-to-use, intuitive and hygienical, this device ensures stable measurements, free from any interference. Certified 93/42/CEE-DM Class IIa

|                   |  |
|-------------------|--|
| Temperature range | Body temperature: 32÷43,9 °C / 89,6÷109,4 °F                   |
|                   | Surface temperature: 0÷60 °C / 32÷140 °F                       |
|                   | Room temperature: 0÷40 °C / 32÷100 °F                          |
| Terms of use      | Environment<br>10÷40 °C / 50÷104 °F<br>Relative humidity ≤ 85% |
| Distance          | 3 ÷ 5 cm (1,2 ÷ 2 pollici)                                     |
| Response time     | <b>1 second</b>  |
| Memory            | last 32 measurements   |
| Battery           | 2 x 1,5 V AAA type   |
| Size              | 100 x 40 x 155 mm  |
| Weight            | 80 g (without battery)   |

# MONITOR

# TG



**NEW PRODUCT**

Art. 8540

## MONITOR TG

### Multiparameter monitor

The TG Monitor is a professional device, equipped with accessories and circuits with a double function: monitoring and diagnosis. This model ensures the collection of vital signs, which can be monitored individually or parallelly.

Features:

- Multiparameter monitoring, with value and tracing
- Battery or current powered – 100 : 240V ca, 50 : 60Hz power source. The battery ensures continuity of use in case of missing power source (up to 4 hours with its standard battery)
- Integrated printer
- Remote controller
- Parameter adjustment and setup
- 10 inch monitor

5 parameters:

- ✓ Ecg - 5 channels / 2 tracks
- ✓ Systolic / diastolic / mean pressure
- ✓ Heartbeat
- ✓ Pulse oximeter
- ✓ Breath monitoring
- ✓ Double probe temperature

Supplied with



**Art. 8540-001**

SpO2 sensor for adults, re-usable



**Art. 8540-002**

Adult cuff 27-35 cm



**Art. 8540-003**

**NEW PRODUCT**

NIBP pediatric cuff 16-21,5 cm



**Art. 8540-004**

**NEW PRODUCT**

NIBP neonatal cuff 10-15 cm



**Art. 8540-005**

**NEW PRODUCT**

Rechargeable lithium battery for TG Monitor



**Art. 8540-006**

**NEW PRODUCT**

Thermal graph paper



Accessories



# TECNOHEART PLUS AED

SEMI-AUTOMATIC DEFIBRILLATOR

|                      |  |
|----------------------|--|
| Dimensions           | 240 x 294 x 95 mm                                  |
| Weight               | 2,65 kg  |
| Length of electrodes | 180 cm   |
| Energy level         | Adult 185-200 J (± 5%)<br>Pediatric 45-50 J (± 5%) |
| Battery life         | 200 shocks / 10 h monitoring                       |
| Battery              | LiMnO2(15V-4200mAh)                                |



Art. 8440

## TECNOHEART PLUS AED

Semi-automatic defibrillator

The AED defibrillators currently on the market are mainly semiautomatic. They are therefore controlled by vocal commands and the shocks are delivered by means of a manual command given by the operator. A simple guided operation.

### Guided vocal instructions

Following the text messages and the vocal instructions, anyone can use this life saving device.

Tecnoheart Plus main features

- ✓ LiMnO2 long life battery: 5 years, 200 discharges
- ✓ Critical components self-test: to keep its efficiency
- ✓ Impedance calculation: to verify the integrity of contact between the AED and the patient
- ✓ Heart on software: useful to archive data concerning AED usage and for firmware updates
- ✓ Pre-connected electrodes: to reduce time interventions
- ✓ IRDA port: to allow pc-defibrillator communication
- ✓ Variable energy: adult (<25kg) from 185 to 200 J/child (<25kg) from 45 to 50 J.

Supplied with

- Art. 8448 Cover
- Art. 8444 Battery
- Art. 8446 Adult/pediatric electrode set

Tecnoheart Plus: technology

- ✓ Biphasic technology, the most advanced system for shocks delivery
- ✓ First shock efficacy: 100%, certified
- ✓ Mean shock per patient: 2.3
- ✓ Time required for an effective defibrillation: 55 secs

# TECNOHEART TRAINER

SEMI-AUTOMATIC DEFIBRILLATOR

|               |  |
|---------------|--|
| Dimensions    | 314 x 259 x 109 mm                     |
| Weight        | 1,9 kg                                 |
| Power         | DC 10,8V / 2200mAh<br>DV 15V / adaptor |
| Static power  | < 5µA                                  |
| Maximum power | < 500mA                                |
| Battery       | Rechargeable 3-cell lithium battery    |



Accessories

**Art. 1370/RB**

Defibrillator case with front pouch

**Art. 8442**

## TECNOHEART PLUS TRAINER

### Semi-automatic defibrillator

The DAE training system is a basic first-response training simulation, for a correct application of the defibrillation procedures by the operators.

#### The DAE Trainer:

- ✓ simulates the provision of electric shocks and ensures a safe use during the training, since it doesn't deliver high voltages,
- ✓ includes 10 preconfigured scenarios of training that simulate realistic episodes of sudden cardiac arrest
- ✓ can be controlled with an infrared remote control that allows scenarios modification during the training so you can test the students' reaction.
- ✓ thanks to its remote control, you can also simulate the shockable rhythm and the non-shockable rhythm.

The PC software allows the configuration of custom scenarios. To connect the device to the PC serial port, you need a standard serial cable D-sub 1: 1 9-pin.

#### Operational conditions

- ✓ Operation: from 0 to 43 °C (from 32 to 109.4 °F)
- ✓ Relative humidity: from 5 to 95% (non-condensing)
- ✓ Altitude: from 0 to 4.475 m

#### Storage conditions:

- ✓ Storage: from -20 to 60 °C (from -4 to 140 °F)
- ✓ Relative humidity: from 5 to 95% (non-condensing)
- ✓ Altitude: from 0 to 12.192 m

#### Remote control:

- ✓ Remote control: DC 3V / Button batteries
- ✓ Static power: < 5uA
- ✓ Maximum power: < 10mA

#### List of components:

- ✓ N° 1 Remote control
- ✓ N° 1 Training electrode for adults (reusable up to 100 times)
- ✓ N° 1 Operator's manual
- ✓ N° 1 Carrying case (Nylon)
- ✓ N° 1 DC adapter
- ✓ N° 1 CD Software DAE Trainer (Optional)

DIAGNOSTICS

# DEFIBRILLATOR DISPLAY CABINET

Art. 8398

## THERMOREGULATED DISPLAY CABINET

Thermoregulated defibrillator display cabinet

Made of P02 carbon steel with a thickness of 15/10, watertight welds, rabbit gaskets, water- and dust-proof door with IP44 degree of protection and snap closure with pull adjustment and potential padlock or seal addition (not included). Hinges in durable, tear-resistant, corrosion-resistant metal alloy. Shelf height-adjustable interior with grating for hot air recirculation. Comfortable techno-polymer handle for easy opening. Internal liquid crystals temperature detection, positioned at the front.

Electric resistance thermoregulation system with thermal protection 80 °C, 200W-230W power, room thermostat + 5 °C / + 20 °C, insulated with cable.

**NOTE: THIS CABINET IS NOT SUITABLE FOR MARITIME LOCATIONS**

|               |                                |
|---------------|--------------------------------|
| Outer size    | 425 x 480 x 215 mm (L x H x P) |
| Internal size | 420 mm (L) - 390 mm (H)        |
| Door light    | 365 mm (L) - 365 mm (H)        |
| Weight        | 14,50 kg                       |

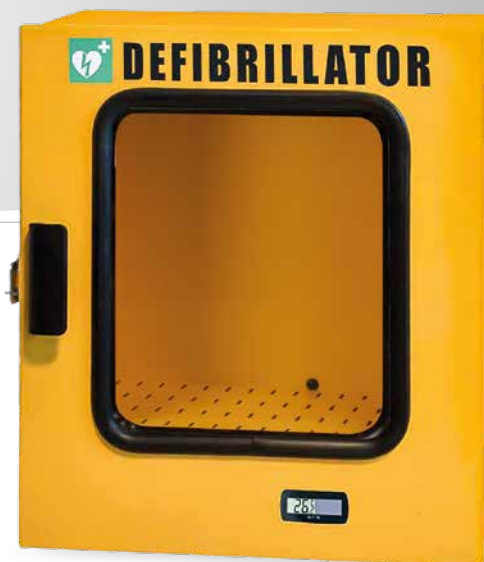

Thermostat display

Art. 8396

## ALARMED THERMOREGULATED CABINET

Alarmed thermoregulated cabinet for defibrillator, equipped with power unit

Main features as per Art. 8398

Equipped with anti-theft magnetic alarm, this cabinet emits a loud noise when drawn without permission. Siren powered by 3 "LR44" batteries. Alarm signal volume 100 dB.

**NOTE: THIS CABINET IS NOT SUITABLE FOR MARITIME LOCATIONS**

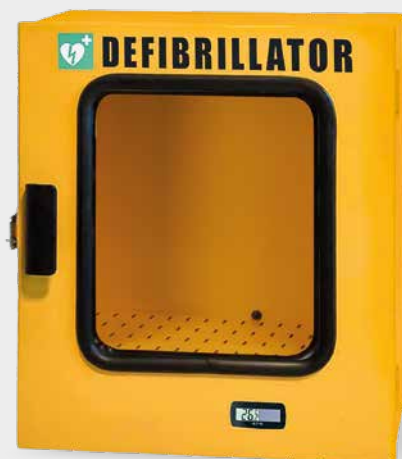

Art. 8432

## STANDARD CABINET

White standard cabinet for  
AED defibrillators



Built in galvanized P02 carbon steel sheet; white RAL9010 epoxy-polyester powder coating; processed in 180° C thermal tunnel. 1 window door; hinges with galvanized pin, opening 180°; lockable seal closure in nickel-plated zamak; pre-drilled for attachment to the wall and on a special floor stand (Art. 8432-001).

|            |                                |
|------------|--------------------------------|
| Outer size | 452 x 425 x 160 mm (L x H x P) |
|------------|--------------------------------|

|        |      |
|--------|------|
| Weight | 6 kg |
|--------|------|

Art. 8432-001

## FLOOR STAND FOR ART. 8432

Floor stand for white  
standard cabinet Art. 8432

Floor stand for white standard cabinet Art. 8432, equipped with holes for floor fastening and interlocking + pre-drilled system to facilitate any wiring and cable passages in safety. Built in galvanized carbon steel sheet P02. Powder coated epoxy-polyester RAL9010 white, processed in thermal tunnel at 180 °C.



|      |                     |
|------|---------------------|
| Size | 250 x 1000 x 150 mm |
|------|---------------------|

|           |              |
|-----------|--------------|
| Base size | 300 x 150 mm |
|-----------|--------------|

Art. 8396-001

## FLOOR STAND FOR ART. 8396 AND 8398

Floor stand for yellow cabinet  
Art. 8396 and 8398

Floor stand for yellow defibrillator cabinet (Art. 8396 and 8398), equipped with holes for floor fastening. Built in galvanized carbon steel sheet P02 7/10. Powder coated epoxy-polyester.



|      |                    |
|------|--------------------|
| Size | 270 x 800 x 120 mm |
|------|--------------------|

|           |              |
|-----------|--------------|
| Base size | 300 x 150 mm |
|-----------|--------------|



# VITAL TEST

HANDHELD PULSE OXIMETER



Art. 11200

## VITAL TEST

Handheld pulse oximeter with adult sensor

Vital Test is a simple and professional device: it can be used in intensive care units, surgeries, dentist's surgeries and emergency rooms, ensuring immediate, accurate and non-invasive monitoring. Vital Test has a pleasant and

Supplied with

**Art. 11206**  
Adult sensor for pulse oximeter (Vital Test)

---

**Art. 11210**  
Vital Test carrying case



ergonomic shape, it is easy to grip and to be transported. Vital Test allows SpO2 measurement, heart-rate detection, waveform visualization and also monitor the last 10 minutes trend value of these two parameters. Supplied with rechargeable battery.

**Accessories**

**Art. 11212**  
Neonatal sensor for Vital Test Pulse oximeter

Pediatric

**Art. 11208**  
Pediatric sensor for Vital Test Pulse oximeter

Pediatric

**Art. 11204**  
Wall-mount Pulse oximeter support

# OXYTEST and SATFINGER II

PORTABLE PULSE OXIMETERS

Supplied with



**Art. 11226**

Adult sensor for OXYTEST pulse oximeter



**Art. 11220**

## OXYTEST

Portable oximeter equipped with adult sensor, USB cable and rechargeable lithium battery.

The Oxytest is a light, easy-to-use pulse oximeter, perfect for transport. Thanks to its sensors Art. 11224 and Art. 11222 (not included), the Oxytest can fit pediatric patients and new-borns. It is powered by means of a rechargeable lithium battery.

- ✓ OLED display, 4 directions to monitor arterial oxygen saturation, pulse rate and pulse strength
- ✓ Battery voltage indicator
- ✓ Standby or automatic sleep mode

Accessories



**Art. 11224**

Pediatric sensor for OXYTEST pulse oximeter



Pediatric

**Art. 11222**

Neonatal sensor for OXYTEST pulse oximeter



Pediatric

**Art. 8336**

## SATFINGER II

Finger pulse oximeter

- ✓ Easy-to-use
- ✓ Portable
- ✓ CE certified
- ✓ For home and professional use



|              |             |
|--------------|-------------|
| Size (LxHxD) | 29x35x69 mm |
| Weight       | 60 g        |

# RESUSCITATION

# 7

Our resuscitation line includes all the devices aimed at the restoration and support of the respiratory system. The range covers laryngoscopes with optical fibre, masks, cannulas, resuscitation bags and other complementary items related to oxygen administration



**Laryngoscopes**



**Resuscitation kits**



**Resuscitation masks**



**Resuscitation bags**



**Oxygen reservoirs and circuits**



**Aerosol Therapy masks**



**Oxygen tank**



**Pressure regulators**

# ION



Discover MeBer products on-line. Shoot the QR code with your tablet or smartphone to land on the dedicated page on the website. You might be required to install a free application to navigate.

Alternatively, go to:  
<https://www.meber.it/en/products/reaanimation.aspx>



# FIBRE OPTIC LARYNGOSCOPES

## MILLER

Miller fibre optic laryngoscope in stainless steel, available in 3 or 4 blades set (handle included)

**Art. 1693**

Fibre optic blade n. 3



**Art. 1692**

Fibre optic blade n. 2



**Art. 1691**

Fibre optic blade n. 1



**Art. 1690**

Fibre optic blade n. 0



**Art. 1689**

Fibre optic blade n. 00



Pediatric

## McINTOSH

McIntosh fibre optic laryngoscope in stainless steel, available in 3 or 4 blades set (handle included)

**Art. 1675**

Fibre optic blade n. 5



**Art. 1674**

Fibre optic blade n. 4



**Art. 1673**

Fibre optic blade n. 3



**Art. 1672**

Fibre optic blade n. 2



**Art. 1671**

Fibre optic blade n. 1



**Art. 1670**

Fibre optic blade n. 0



Pediatric

**Art. 1696**

**Laryngoscope set with 3 fibre optic blades**  
(Art.1692 - 1691 - 1690) **with case and handle**

**Art. 1697**

**Laryngoscope set with 4 fibre optic blades**  
(Art.1693 - 1692 - 1691 - 1690) **with case and handle**

**Art. 1678**

**Laryngoscope set with 3 fibre optic blades**  
(Art.1674 - 1673 - 1672) **with case and handle**

**Art. 1677**

**Pediatric laryngoscope set with 3 fibre optic blades**  
(Art.1672 - 1671 - 1670) **with case and handle**

**Art. 1679**

**Laryngoscope set with 4 fibre optic blades**  
(Art.1674 - 1673 - 1672 - 1671) **with case and handle**

**Art. 1620-001**  
**Laryngoscope carrying case**

Laryngoscope case.  
Fit for 3-4 blades kit with handle.

**Art. 1682**

Pediatric handle for fibre optic laryngoscope

**Art. 1683**

Adult handle for fibre optic laryngoscope

**Art. 1681**

2.5V halogen bulb for fibre optic laryngoscope handle



# STANDARD LIGHT LARYNGOSCOPES

## MILLER

Miller standard light laryngoscope in stainless steel, available in 3 or 4 blades set (handle included, Art. 1650)

### Art. 1634

Standard light laryngoscope blade n. 4



### Art. 1633

Standard light laryngoscope blade n. 3



### Art. 1632

Standard light laryngoscope blade n. 2



### Art. 1631

Standard light laryngoscope blade n. 1



### Art. 1630

Standard light laryngoscope blade n. 0



Pediatric

## McINTOSH

McIntosh standard light laryngoscope in stainless steel, available in 3 or 4 blades set (handle included Art. 1650)

### Art. 1615

Standard light laryngoscope blade n. 5



### Art. 1614

Standard light laryngoscope blade n. 4



### Art. 1613

Standard light laryngoscope blade n. 3



### Art. 1612

Standard light laryngoscope blade n. 2



### Art. 1611

Standard light laryngoscope blade n. 1



### Art. 1610

Standard light laryngoscope blade n. 0



Pediatric

### Art. 1638

Laryngoscope set with 3 standard light blades (Art. 1633 - 1632 - 1631) with handle and case

### Art. 1640

Laryngoscope set with 4 standard light blades (Art. 1633 - 1632 - 1631 - 1630) with handle and case

### Art. 1618

Laryngoscope set with 3 standard light blades (Art. 1614 - 1613 - 1612) with handle and case

### Art. 1619

Laryngoscope set with 3 standard light blades (Art. 1612 - 1611 - 1610) with handle and case

### Art. 1620

Laryngoscope set with 4 standard light blades (Art. 1614 - 1613 - 1612 - 1611) with handle and case

**Art. 1620-001**  
Laryngoscope carrying case

Laryngoscope case.  
Fit for 3-4 blades kit with handle.

**Art. 1645**

Pediatric handle for standard light laryngoscope

Pediatric

**Art. 1650**

Adult handle for standard light laryngoscope

**Art. 1655**

Spare bulb



RESUSCITATION

# RESUSCITATION KIT



Art. 2050

## SPEEDY 2

### Resuscitating set without tank

Resuscitator in ABS set with support, resuscitator bag, resuscitation mask (size 4), 3 Guedel cannulas (size 1-2-3), tongue puller, mouth opener, non-toxic tube.

Size: 40 x 26 x 13 cm

Art. 1090

## GAG

### Helicoidal gag

Helicoidal gag in polyethylene with non-slip knurled knob for a secure grip



# CANNULAS AND MASKS

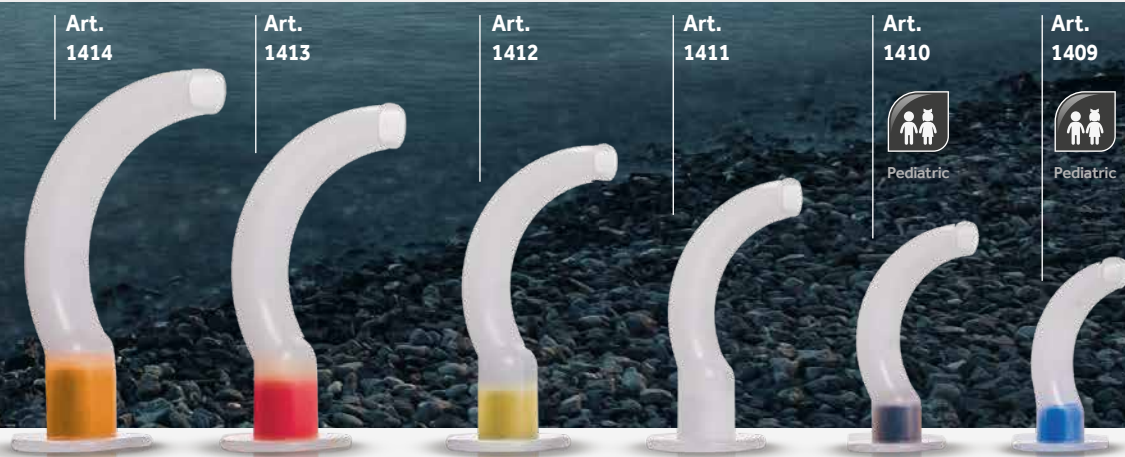

Art. 1409 - 1410 - 1411 - 1412 - 1413 - 1414

## GUEDEL CANULAS

### Guedel pattern airway

Guedel pattern airway, made in nontoxic material, sterile and single-packed. **There are 6 available sizes, in 6 different colours.**

| Item code | 1409 | 1410 | 1411 | 1412 | 1413 | 1414 | 1415 |
|-----------|------|------|------|------|------|------|------|
| Size      | 00   | 0    | 1    | 2    | 3    | 4    | Set  |



Art. 1080

## RESCUE MASK

### Resuscitation mask

Indispensable for all rescue operators, this mask avoids any contact between mouths during emergency reanimations. Made of transparent material, it is composed by a soft cushion and a non-return valve. The mask fits in a soft, shock-proof plastic case. The case colour could change.



Art. 1787

## KEYRING

### Keyring with mouth-to-mouth mask

Mouth-to-mouth safety mask that allows ventilation in complete safety thanks to a transparent sheet and a non-return valve which prevents the patient's exhalation from coming into contact with the rescuer. It is supplied in a handy container with keyring. The case colour could change.



RESUSCITATION

# RESUSCITATION MASKS



Art. 2400 - 2401 - 2402 - 2403 - 2404 - 2405

## SILICONE MASK

Resuscitation and anesthesia face mask

Resuscitation and anesthesia face mask. The anatomical border in silicone guarantees perfect fitting to the face while the shell, made in transparent material, allows the patient to be monitored during the application. Standard connector. Can be autoclave sterilized, available in 6 sizes.

| Item code | 2400 | 2401 | 2402 | 2403 | 2404 | 2405 |
|-----------|------|------|------|------|------|------|
| Size      | 0    | 1    | 2    | 3    | 4    | 5    |



Art. 2411 - 2413 - 2414 - 2415

## DISPOSABLE MASK

Disposable resuscitation mask

Disposable resuscitation face mask. Size 3-4-5 also feature valve and spider.

| Item code | 2411 | 2413 | 2414 | 2415 |
|-----------|------|------|------|------|
| Size      | 1    | 3    | 4    | 5    |

# RESUSCITATION BAGS



Art. 1274 - 1276 - 1278

## RESUSCITATION BAGS

### Silicone resuscitation bags

Transparent, autoclavable, equipped with safety valve with adjustment at 60 mbar for adults and 40 mbar for children and new-borns. Equipped with connections for oxygen tank, reservoir and masks.

Art. 1230 - 1235

## DISPOSABLE BAGS

### Disposable resuscitation bags with mask

Disposable resuscitation bags for adults with disposable mask. Equipped with non-return valve.

| Item code    | 1274 | 1276 | 1278 | 1230 | 1235 |
|--------------|------|------|------|------|------|
| Volume (ml)  | 1700 | 500  | 350  | 1700 | 500  |
| Autoclavable | ✓    | ✓    | ✓    |      |      |
| Safety valve | ✓    | ✓    | ✓    | ✓    | ✓    |

Accessories



**Art. 12028**  
Blue case for resuscitation bag and mask

Size: 22 x 30 x 12 cm (LxHxD). Weight: 0.8 kg.



**Art. 1056**  
Extension tube for oxygen f/f 2 metres long



**Art. 1057**  
Goggles for oxygen therapy with rear sliding fastener

# OXYGEN RESERVOIRS and **MANUAL CIRCUITS**



Art. 1258

## ADULT DISPOSABLE CIRCUIT

Manual resuscitation circuit for adults

Manual BVM resuscitation circuit for adults, equipped with:

- ✓ 1000 ml bag
- ✓ Pressure limit valve (40 cmH2O)
- ✓ Size 4 mask
- ✓ Reservoir
- ✓ Oxygen tube extension



Pediatric



Art. 1257

## DISPOSAL PEDIATRIC CIRCUIT

Manual resuscitation circuit for children

Manual BVM resuscitation circuit for children, equipped with:

- ✓ 550 ml bag
- ✓ Pressure limit valve (40 cmH2O)
- ✓ Size 3 mask
- ✓ Reservoir
- ✓ Oxygen tube extension



Pediatric



Art. 1256

## DISPOSAL NEONATAL CIRCUIT

Manual resuscitation circuit for new-borns

Manual BVM resuscitation circuit for new-borns, equipped with:

- ✓ 280 ml bag
- ✓ Pressure limit valve (40 cmH2O)
- ✓ Size 1 mask
- ✓ Reservoir
- ✓ Oxygen tube extension



Art. 1233

Resuscitation bag - Oxygen reservoir with valve for adults



Pediatric



Art. 1234

Resuscitation bag - Oxygen reservoir with valve for children

# AEREOSOL THERAPY MASKS



Art. 1053

## Adult mask for inhalation therapy

Soft mask for inhalation therapy equipped with ampulla and anti-flattening connection tube



Art. 1052

## Oxygen therapy mask for adults - variable concentration - Venturi system

Soft mask system equipped with coloured connections kit for oxygen modulation and anti-flattening connection tube



Pediatric

Art. 1040

## Oxygen therapy mask for children

High concentration oxygen therapy mask for children. Produced with non-toxic material, complete with adjustable elastic, clip for nose and connecting tube of cm 210



Pediatric

Art. 1045

## Oxygen therapy mask for children with bag

High concentration oxygen therapy mask for children. Produced with non-toxic material, complete with bag, adjustable elastic, clip for nose and connecting tube of cm 210



Art. 1050

## Oxygen therapy mask for adults

High concentration oxygen therapy mask for adults. Produced with non-toxic material, complete with adjustable elastic, clip for nose and connecting tube of cm 210



Art. 1055

## Oxygen therapy mask for adults with bag

High concentration oxygen therapy mask for adults. Produced with non-toxic material, complete with bag, adjustable elastic, clip for nose and connecting tube of cm 210



RESUSCITATION

# OXYGEN TANKS

Art. 1465



Art. 1468



Art. 1470



Art. 1475



Art. 1478



Art. 1465 - 1468 - 1470 - 1475 - 1478

## OXYGEN TANKS

Tanks for oxygen therapy

Tanks for oxygen therapy in compliance with F.U. norms, produced with stainless steel, refillable and provided with test certificate.

| Item code | Capacity | Gaseous capacity | Height | Diameter | Weight   |
|-----------|----------|------------------|--------|----------|----------|
| 1465      | 0,5 L    | 75 L             | 370 mm | 60 mm    | 2,90 kg  |
| 1468      | 2 L      | 300 L            | 400 mm | 120 mm   | 4,10 kg  |
| 1470      | 5 L      | 1000 L           | 550 mm | 140 mm   | 9,20 kg  |
| 1475      | 7 L      | 1400 L           | 700 mm | 140 mm   | 10,80 kg |
| 1478      | 10 L     | 2000 L           | 955 mm | 137 mm   | 13,25 kg |

Art. 1440



Art. 1441



Art. 1442



Art. 1440 - 1441 - 1442

## OXYGEN TANKS WITH PRESSURE REGULATOR

Oxygen tanks with pressure regulator and cover

Tanks for oxygen therapy in compliance with F.U. norms, produced with stainless steel, refillable and provided with test certificate.

| Item code | Capacity | Height | Diameter |
|-----------|----------|--------|----------|
| 1440      | 2 L      | 435 mm | 110 mm   |
| 1441      | 3 L      | 565 mm | 110 mm   |
| 1442      | 5 L      | 620 mm | 140 mm   |

# PRESSURE REGULATORS



Art. 1452

## STANDARD PRESSURE REGULATOR

Standard pressure regulator with dispenser

Diaphragm pressure reducer with manometer and dispenser to regulate the supply of oxygen



Art. 1455

## FLOW METER REGULATOR

Flow meter pressure regulator

Diaphragm pressure reducer with pressure gauge equipped with rotameter flowmeter 0 - 15 liters / min with hose connection. Safety valve with 7 bar calibration.



Art. 1460

## FLOW METER REGULATOR AND HUMIDIFIER

Flow meter pressure regulator with humidifier

Diaphragm pressure regulator equipped with pressure gauge rotameter flowmeter 0 - 15 liters / min and humidifier in makrolon. Safety valve with 7 bar calibration.

# FIRST AID EQUIPMENTS

# 8

Thanks to his own equipment, a rescuer can make a difference on the field. Besides the main rescue devices, many more products play a critical role in first aid operations. We have selected tens of products in order to enable any structure, team and rescuer to work everywhere in the best conditions. As far as rescue knapsacks are concerned, we have found numerous solutions suitable to the various existing specializations.





Discover MeBer products on-line. Shoot the QR code with your tablet or smartphone to land on the dedicated page on the website. You might be required to install a free application to navigate.

Alternatively, go to: <https://www.meber.it/en/products/first-aid-equipments.aspx>



FIRST AID EQUIPMENTS

# RESCUE KNAPSACKS

NEW  
PRODUCT

Art. 1318

## ROMEO

Rescue knapsack



Modular knapsack, compact and simple, suitable for volunteers and rescue professionals. Entirely made in red closed-cell PVC. Tearproof, washable and resistant, with transparent front pocket for customization and internal bands for objects, with double stitching, 10 mm strong zip, high visibility reflective bands on all external sides, PVC base and plastic supports. Equipped with an internal rigid protective shell structure made of thermoplastic material and with a large central compartment with double zip front opening and 2 external front pockets. The central unit compartment is equipped with Velcro® attachments for the anchoring of 4 standard colored cases (Art. 1362-002), and 2 professional bags (Art. 1362-001). Two rubber-coated handles complete the non-slip backpack for carrying by hand, together with its two shoulder straps reinforced with reflective bands.

**Size: 33 x 54 x 36 cm (W x H x D). Weight: 3,8 kg**

NEW  
PRODUCT

Art. 1319

## GIULIETTA

Emergency bag



Red Emergency bag made in closed-cell PVC, with PVC bottom, plastic supports and upper transparent pocket for customizations. Compact but roomy, thanks to its internal modularity it allows the organization of space in a personalized way in order to optimally house what is necessary for emergencies. 4 pockets, 2 on the sides, one front and one rear, predisposed with supports and rubber bands. It is also equipped with an additional removable bag with transparent front. Thanks to its construction, it allows internal cleaning and disinfection. Portable by hand, shoulder strap or as a backpack.

**Size: 45 x 33 x 34 cm (W x H x D). Weight: 2,2 kg**

FIRST AID EQUIPMENTS

# RESCUE KNAPSACKS

Art. 1325/BR

Art. 1325/RG

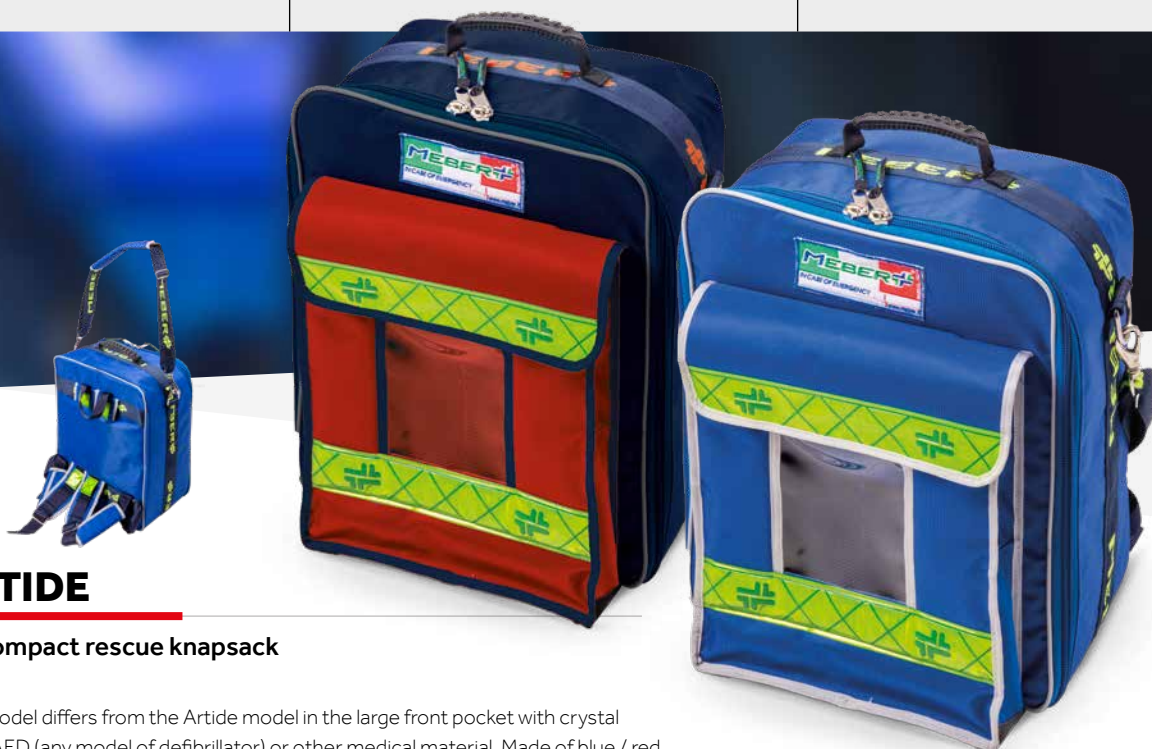

Art. 1325

## ANTARTIDE

Complete compact rescue knapsack

The Antarctic model differs from the Artide model in the large front pocket with crystal window for the AED (any model of defibrillator) or other medical material. Made of blue / red or royal blue nylon with double stitching, large high visibility reflective bands, PVC bottom, reinforced shoulder straps for shoulder transport. The large external pocket favors the rescuer by giving a clear view of the content. Internally it is equipped with Velcro® attachments for the anchoring of 3 professional bags (blue, yellow and green), supplied with the knapsack.

**Size: 36 x 44 x 29 cm (W x H x D). Weight: 3,9 kg**



Art. 1326

## ARTIDE

Complete compact rescue knapsack

Rescue knapsack, made in royal blue tear-resistant nylon with double stitching, large high visibility reflective bands, PVC bottom, reinforced and detachable shoulder straps for shoulder transport. Internally it is equipped with Velcro® attachments for the anchoring of 3 professional bags (blue, yellow and green), supplied with the knapsack.

**Size: 36 x 44 x 23 cm (W x H x D). Weight: 3,6 kg**



FIRST AID EQUIPMENTS

# RESCUE KNAPSACKS

NEW  
PRODUCT

Art. 1322

## ATENE

### Red professional rescue knapsack

Athens is the backpack that meets the rescuer's needs: compact, functional and light. The central compartment is equipped with Velcro® attachments for the anchoring of six coloured bags (supplied with the knapsack). Equipped with a front pocket and two small double zip side pockets. The backpack is completed by three high visibility reflective bands (1 front and 2 on the sides) and front and side elastic bands to accommodate sanitary material of various kind.

**Size: 40 x 50 x 24 cm (W x H x D). Weight: 1,6 kg**



Art. 1390

## YANKEE

### Red Cordura Backpack

Compact and functional backpack. Made in tear-proof fabric, it is equipped with a front and a central pocket for medical supplies. Large high visibility reflective strips on the front side and on the shoulder straps. Particularly fit for footed rescuers or nurses for the stashing of medical equipment, thanks to its small size

**Size: 33 x 49 x 8 cm (W x H x D). Weight: 1 kg**



# RESCUE KNAPSACKS

Art. 1362

## AMBUMED

### Rescue knapsack



New modular knapsack, practical, compact, simple and suitable for rescue volunteers and professionals. Externally it is made of blue tear-resistant double stitched nylon, sturdy 10 mm zips, reflective high visibility strips on all sides and a closed-cell PVC bottom, with plastic supports. On the inner side there is a protective hard shell structure made of thermoplastic material, consisting of a central wide space, characterized by a double-zip opening and 4 external side pockets. The central space is supplied with Velcro® straps for the anchoring of 4 coloured cases, each one supplied with a large transparent window reinforced with double stitching, and 2 professional bags to store and organize different tools and materials. This knapsack is completed by a frontal pocket with inner straps to secure different objects, 3 anti-slip rubber handles (1 on the upper side and 2 on the lateral sides, 2 shoulder bands with reflecting stripes on the back.

**Size: 53 x 53 x 25 cm (W x H x D). Weight: 4,1 kg**

Art. 1343

## RESCUEMED

### Rescue knapsack



Made of red tear-resistant material, the RESCUEMED pack is ideal for first aid operators thanks to its versatility and robust qualities. Ample front pockets to ensure that all necessary materials are at hand. Internally, it is equipped with smaller bags, with and without handles, permitting instant recognition of the instruments necessary for the intervention. Two yellow reflective strips complete the features of this first aid knapsack.

**Size: 37 x 52 x 29 cm (W x H x D). Weight: 3,5 kg**

FIRST AID EQUIPMENTS

# RESCUE KNAPSACKS



Art. 1354

**115**

## Red knapsack with side pockets and compartments

Knapsack made of red anti-tear nylon, double seams, reflective strips, reinforced shoulder straps and sturdy 10 mm zips. Supplied with front opening wide space inside of which are 4 rack pockets to store various devices. Possibility to fix 2 litres oxygen tanks. Two wide lateral sections contain four bags in different colours allowing a fast identification of the kits. PVC Water-proof bottom.

**Size: 44 x 56 x 26 cm (W x H x D). Weight: 4 kg**



Art. 1354-001

## Carrying bag for knapsack "115"

Carrying bag for Art. 1354, produced with fire-proof PVC. This bag ensures stowage and transport of the knapsack to preserve its integrity.

**Weight: 1,2 kg**



Accessories



# ACCESSORIES FOR RESCUE KNAPSACKS

Art. 1373

## Green multi-functional roll bag

Practical and functional accessory, designed for the placement of medical, intubation and resuscitation devices. Internally the roll is equipped with rubber bands that block medical instruments and a transparent zippered pocket. Innovative accessory, adaptable to any type of rescue backpack.



Art. 1362-001

## Square bags

Yellow, green, red and blue square bags for knapsacks

Size: 23 x 23 x 10 cm (W x H x D).

Art.  
1362-001/V

Art.  
1362-001/G

Art.  
1362-001/R

Art.  
1362-001/B



Art. 1362-002

## Rectangular bags

Yellow, orange, red and blue rectangular bags for knapsacks.

Size: 30 x 15 x 10 cm (W x H x D).

Art.  
1362-002/R

Art.  
1362-002/Y

Art.  
1362-002/B

Art.  
1362-002/A



Art. 1362-003

## Rectangular bags

Professional rectangular bags for rescue knapsacks. Available in yellow (Art. 1362-003/G), orange (Art. 1362-003/A), Blue (Art. 1362-003/B) and green (Art. 1362-003/V), also in its pediatric version (Art. 1362-003/PED).

Size: 35 x 19 x 14 cm (W x H x D).

Weight: 0,5 kg

Art.  
1362-003/G

Art.  
1362-003/A

Art.  
1362-003/B

Art.  
1362-003/V

Art.  
1362-003/PED



Pediatric



FIRST AID EQUIPMENTS

# EMERGENCY RESCUE BAGS



Art. 1365

## NEVADA

### Emergency rescue bag

Bag made of royal blue coloured nylon. It is equipped with high visibility reflective stripes, sturdy double zips, a comfortable shoulder strap with metal hooks and handles to carry by hand. The bag is made up of a central space divided into 3 wide compartments with rigid adjustable dividers. Externally it is characterized by a frontal compartment with a pocket and fixed dividers, 3 side pockets with zip and two open compartments for the placement of bottles of various kinds. It is completed by a customizable name plate on the lateral side. The bottom is in water-proof PVC with plastic support feet. The linings can be easily removed to allow internal cleaning and disinfection.

**Size: 50 x 25 x 28 cm (W x H x D). Weight: 1,5 kg**



Art. 1345

## EMERGENCY RESCUE BAG

### Empty emergency bag

Emergency rescue bag made of Nylon 840. It is compact but roomy and, thanks to its internal modularity, it allows personalized organization of the space so that everything required for an emergency can be housed in the best way. It is made up of 4 identical pockets, 2 side ones, a front one and a back one, which are prepared and provided with supports and elastics for holding medical material. It also houses another small removable bag with a transparent front that allows the content to be seen. Thanks to its construction, the linings can be completely removed to allow internal cleaning and disinfection. Can be carried by hand, over the shoulder or as a backpack.

**Size: 45 x 33 x 34 cm (W x H x D). Colour: Red. Weight: 1,8 kg**



FIRST AID EQUIPMENTS

# EMERGENCY RESCUE BAGS



Pediatric

Art. 1342

## BABY BAG

Empty emergency bag



Pediatric emergency rescue bag made in Nylon with waterproof PVC coating. It consists of three inner compartments, a removable bag with transparent front that enables to see the content. It is equipped with 4 external pockets, two at the sides and two at the front. It can be carried by hand, over the shoulder or as a backpack.

**Size: 45 x 30 x 30 cm (W x H x D). Weight: 1,4 kg**

Art. 1370/RB

## DEFIBRILLATOR CASE

Defibrillator case with front pocket

Universal defibrillator case, practical and functional. It is equipped with a double-zip opening, a water-proof PVC bottom and support feet positioned both on the bottom and on the back side, in order to ensure that the medical device is stable and protected. On the inner side there is a section with Velcro® straps to hold the device and a transparent pocket to store spare electrodes. Externally it has a big frontal service pocket, allowing to carry a whole resuscitation kit. It is completed with an anti-slip rubber handle and a shoulder strap with metal hooks. It can be carried both by hand and over the shoulder and it is available in red or blue colour.

**Size: 28 x 32 x 20 cm (W x H x D). Weight: 1 kg**





FIRST AID EQUIPMENTS

# POUCHES and VIAL HOLDERS

Art. 1350

## VIAL HOLDER

Bag with partitions for vials transport

Indispensable vial holder for protection and identification of any kind of vials. Made of nylon, it consists of 2 compartments, one split in 3 parts and one in 2 parts. Equipped with elastic bands to fix up to 90 vials and internal transparent windows for customization.

**Size: 18 x 28 x 13 cm (W x H x D).**



# PHARMA-MED



Art. 1375

## PHARMA-MED

**Professional bag with compartments for drugs transport**

Made of tearproof, waterproof and fireproof nylon, it is equipped with sturdy zippers, a comfortable handle covered in rubber and 4 support feet in plastic material to isolate the device from the support surface. It consists of three different sections. The sector Liquids and Powders is centrally positioned and is divided into 3 sections, equipped with elastic bands for vials, interspersed with two polyurethane foam membranes (slow-recovery) to protect the vials from breaking. The COLD sector, marked by the red Cordura, is equipped with elastic bands for vials on one side and reusable hot / cold gel bags on the other (supplied with 6 Mini Dispogels). The Capsule compartment consists of a transparent pocket with a zip and a transparent pocket with Velcro® straps for boxes or blisters. Pharma-Med is equipped with a transparent external pocket for the placement of a check list or a medication expiration date.

**Size: 20 x 16 x 28 cm (W x H x D).**

**Number of vials contained: min 108 – max 120. Weight: 1,1 kg**

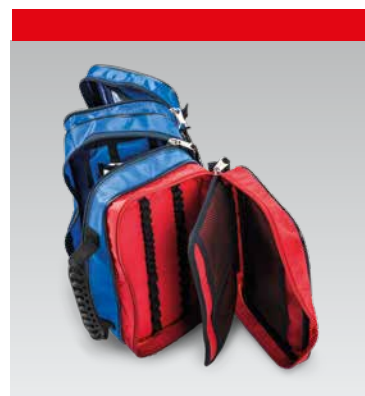
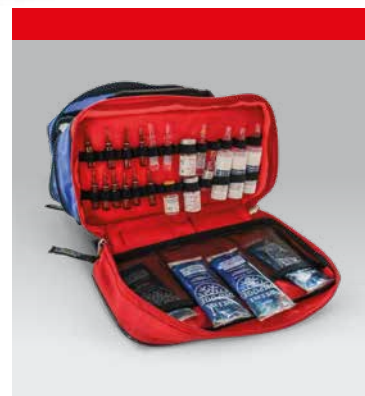

Accessories



Art. 1375-001

**Re-usable HOT/COLD Gel bag 5,5x12 cm for drug transport bags**

FIRST AID EQUIPMENTS

# INSTRUMENT HOLDERS

Art. 1355/B

## INSTRUMENT HOLDER

Blue MeBer instrument holder

Belt instrument holder made of blue tear-resistant material. It can hold essential first-aid instruments such as sphygmomanometers, phonendoscopes, clothes-cutting scissors, latex gloves, etc.

**Size: 11 x 18 x 10 cm (W x H x D)**



Art. 1356/B

## INSTRUMENT HOLDER

Blue MeBer instrument holder with reflective strip

Handy instrument holder to be fixed to the waist belt. Equipped with three pockets and a reflection band, it is an ideal solution to easily carry any essential first aid tool.

**Size: 18 x 13,5 x 2,5 cm (W x H x D)**



FIRST AID EQUIPMENTS

# TOOLS KIT and ASPIRATORS



Art. 1360

## TOOLS KIT

### Emergency vehicles tools kit

Tools kit for road accidents, ideal for all rescue vehicles.  
All tools needed are included inside of a convenient nylon case.

**Size: 48 x 28 x 12 cm (W x H x D)**

Content:

- ✓ 1 axe
- ✓ 1 crowbar
- ✓ 2 wind-proof torches
- ✓ 2 pairs of professional gloves
- ✓ 1 bolt cutter
- ✓ 1 tow cable
- ✓ 1 smoke candle
- ✓ 1 fire blanket

Art. 11068

## Manual suction unit

This device was designed to ensure optimal pharyngeal and tracheal aspiration in emergency procedures.  
The secretion collection jar volume is 300 ml.

**Size: 12,5 x 6 x 16 cm. Weight 200 g**



# CORMOS

PORTABLE ASPIRATOR FOR SECRETIONS

Art. 11010/FA

With autoclavable  
canister



Art. 11014



Art. 11010/LN

With disposable liner

Art. 11010

## CORMOS

Portable aspirator for secretions

Compact and powerful, indicated for emergency services. CORMOS works directly with the 12V of the vehicle or with an inner accumulator with more than 45 min. of autonomy. CORMOS is silent and powerful thanks to its engine of 24 litres/min which enables a constant aspiration, with control manometer, positioned on the front of the aspirator, up to 850 mbar. Easy to carry thanks to its compact dimension, the anatomic handle and its limited weight. New case design, made of ABS/UL high resistance anti-shock material. It is supplied with connection cable to the 12V of the vehicle, carrying case, wall locking device 10G proof as per EN 1789 normative for the use inside emergency vehicles, 1000 ml autoclavable canister with safety valve and antibacterial filter to fix directly onto the cap.

Item complies to ISO 10079-1; IEC 600601-1 3rd ed., approval e1 according to Directive 72/245/EEC, UNI EN 1789, IEC 60601-1-11.

Classification according MDD 93/42/EEC: IIb.



Art. 11128/FA







Art. 11128/LN

Art. 11128

## On board medical suction unit

### On board suction unit with autoclavable canister

- ✓ On board suction unit for rescue vehicles
- ✓ Maximum aspiration flow 30lt/min.
- ✓ Maximum aspiration Power 800 mbar.
- ✓ 1000 ml Autoclavable canister with disposable cartridge (model LN)
- ✓ 1000 ml autoclavable canister with safety valve and protection filter directly fixed onto the cap (model FA)
- ✓ Engine block size: approx. 18x19x9 cm. Built-in regulator block size: 9x13x8.5 cm approx.
- ✓ In compliance with all existing norms.

|               |  |   |   |
|---------------|--|---|---|
| Supplied with |  <p><b>Art. 11028</b><br/>Autoclavable collection canister ml 1000 for disposable liner</p> |  <p><b>Art. 11023</b><br/>10 Proof wall mount with integrated CORMOS and CORMOS PLUS charging system</p> |  <p><b>Art. 11016</b><br/>Green case</p> |
|               |  <p><b>Art. 11014</b><br/>Rigid aspiration probe</p>  |  <p><b>11034</b><br/>220V 2-pole power supply. Output voltage 13.7 V</p>                                 |   |

|             |   |  |   |  |
|-------------|---|--|---|--|
| Accessories |  <p><b>Art. 11162</b><br/>1 litre disposable vase for secretion collection</p> |  <p><b>Art. 11024 (6 pcs.)<br/>Art. 11025 (12 pcs.)<br/>Art. 11026 (36 pcs.)</b><br/>Disposable 1000 ml bag</p> |  <p><b>Art. 11012</b><br/>Autoclavable vase for collection</p> |  <p><b>Art. 11013</b><br/>Antibacterial filter</p>                                  |
|             |   |  |   |  <p><b>Art. 11022-001</b><br/>2011 Power supply / 3-pole 12VCC for suction unit</p> |
|             |   |  |   |  |
|             |   |  |   |  |

# CORMOS

## PLUS

PORTABLE ASPIRATOR  
FOR SECRETIONS



Art. 11022/FA

Portable aspirator  
for secretions with  
autoclavable canister

Art. 11022

## CORMOS PLUS

Portable aspirator for secretions

The CORMOS PLUS suction units are easy-to-use and compact battery powered medical devices. They differ from the CORMOS series for their higher power supplied by a suction flow of 30 liter/minute engine. The suction rate can be controlled thanks to a 800 mbar manometer. Supplied with: carrying case, 10G proof wall mount as per EN1789 for rescue vehicles operations, 1000 ml autoclavable canister with safety valve and antibacterial filter, tube with Jankauer probe and universal battery charger.

Item complies to

**ISO 10079-1; IEC 600601-1 3rd ed., approval e1 according to Directive 72/245/EEC, UNI EN 1789, IEC 60601-1-11.**

**Classification MDD 93/42/EEC: IIb.**



**Art. 11022/LN**

**Portable aspirator with vase and adapter for disposable bags**

Supplied with



**Art. 11028**

Autoclavable collection canister ml 1000 for disposable liner.



**Art. 11023**

10 Proof wall mount with integrated CORMOS and CORMOS PLUS charging system



**Art. 11032**

Green case

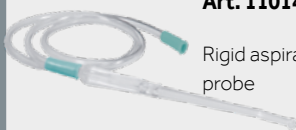

**Art. 11014**

Rigid aspiration probe



**11034**

220V 2-pole power supply. Output voltage 13.7 V

Accessories



**Art. 11162**

1 litre disposable vase for secretion collection



**Art. 11024 (6 pcs.)  
Art. 11025 (12 pcs.)  
Art. 11026 (36 pcs.)**

Disposable 1000 ml bag



**Art. 11012**

Autoclavable vase for collection



**Art. 11013**

Antibacterial filter



**Art. 11022-001**

2011 Power supply / 3-pole 12VCC for suction unit



FIRST AID EQUIPMENTS

# FIRST AID EQUIPMENTS

Art. 706 - 708

## TRANSFER SHEET

Transfer sheet with 6/8 handles

Transfer sheet made of fire-proof, tear-proof, water-proof nylon.  
Available with 6 or 8 strong handles.

**Capacity 160 kg. Size: cm 192 x 75**



Art. 706



Art. 708

Art. 712

## TRANSFER SHEET

Obese transfer sheet with 12 handles

Made of fire-proof, tear-proof, water-proof nylon.  
Equipped with 12 reinforced handles.

**Capacity 350 kg. Size: cm 274 x 150**



Bariatric



NEW PRODUCT

Art. 714

## TRANSFER SHEET

Obese transfer sheet with 12 handles 200x150 cm

Same features of art. 712 but different dimensions: 200 x 150 cm.

**Capacity 350 kg. Size: cm 200 x 150**



Bariatric





Art. 1980



Art. 1982

Art. 1980 - 1982

## SCISSORS

Emergency scissors

Multi-purpose emergency scissors, ideal for rescue operators. Produced in stainless steel and plastic-coated handles. Ideal for glass breaking, clothes cutting and safety belts cutting in emergency rescue. Supplied with wall mount.

Art. 1950/N

Art. 1950/R

Art. 1950/G



Art. 1950

## SCISSORS

Emergency scissors

Emergency scissors with thermoplastic handles and steel blade for clothes cutting. Available in 3 different colours: black (1950/N), yellow (1950/G) and red (1950/R).

Length cm 18

Art. 1910 - 1905

## ICE BAG

Instant ice bag

Disposable instant ice bag with a 30 minutes constant-temperature autonomy. Available in PVC bag (art. 1910) or TNT bag (Art. 1905), which produces less outer condensation. **25 pieces per box. Size: cm 14 x 18.**



Art. 1910

Art. 1905

Art. 1915

## SPRAY ICE

Instant spray ice

Instant spray ice in spray can (400 ml), idea for bruises and traumas. **24 pieces per box.**



Art. 1960

## TOURNIQUET

Adjustable tourniquet

Adjustable tourniquet with quick opening for a faster application. Fit for rescue knapsacks and bags



FIRST AID EQUIPMENTS

# FIRST AID EQUIPMENTS



Art. 12026

## GLOVE BOX

3-tier glove box for rescue vehicles

Practical and safe ABS structure to contain 3 boxes of disposable gloves. Equipped with safety locking system to avoid accidental opening. Its smooth surface and curved angles make it extremely safe and easy to clean. It can be installed in any type of ambulance.

Height 410 mm, Width 260 mm, Depth 95 mm, Weight 1 kg



## GLOVES

Disposable latex and nitrile gloves in 4 sizes

### LATEX GLOVES

|                     |                     |                     |                      |
|---------------------|---------------------|---------------------|----------------------|
| Art. 1930<br>SIZE S | Art. 1932<br>SIZE M | Art. 1934<br>SIZE L | Art. 1935<br>SIZE XL |
|---------------------|---------------------|---------------------|----------------------|

### LATEX GLOVES

|                     |                     |                     |                      |
|---------------------|---------------------|---------------------|----------------------|
| Art. 1936<br>SIZE S | Art. 1937<br>SIZE M | Art. 1938<br>SIZE L | Art. 1939<br>SIZE XL |
|---------------------|---------------------|---------------------|----------------------|

### DOUBLE THICK LATEX GLOVES

|                     |                     |                     |                      |
|---------------------|---------------------|---------------------|----------------------|
| Art. 1925<br>SIZE S | Art. 1926<br>SIZE M | Art. 1927<br>SIZE L | Art. 1928<br>SIZE XL |
|---------------------|---------------------|---------------------|----------------------|

### NITRILE GLOVES

|                     |                     |                     |                      |
|---------------------|---------------------|---------------------|----------------------|
| Art. 1940<br>SIZE S | Art. 1942<br>SIZE M | Art. 1944<br>SIZE L | Art. 1945<br>SIZE XL |
|---------------------|---------------------|---------------------|----------------------|

Art. 11360/B



Art. 11360

Art. 11362/G



Art. 11360/R



## HELMET

Protective emergency helmet in white, red or yellow ABS

Anti-suffocation throat-strap with automatic release between 15 dN and 25 dN. Inner washable padding, spider shape. Conform to CE EN 397

Accessories

Art. 11372

Clear visor



Art. 1776/R - 1776/AZ

## RESCUE BLANKET

Pile rescue blanket

Red and blue pile blanket, sewn on all perimeter, supplied with 2 reflecting bands

Size: cm 140x210.



Art. 1776/R

Art. 1776/AZ



Art. 1770

## RESCUE BLANKET

Isothermal blanket

Necessary article for the first aid. Two-sides, one gold and one silver, this blanket protects from severe weather conditions (heat or freezing). Packed in a re-closable bag.

Size: cm 160x210.

Art. 1385 - 1388

## PILLOWCASE

Disposable TNT pillowcase

Disposable TNT pillowcase. Available in green (25 gr/mq - cm 50x70) and white (28 gr/mq - cm 50x80). Packed in 50 pieces

Art.  
1385

Art.  
1388



Art.  
1380

Art.  
1382



Art. 1380 - 1382

## BED STRETCHER SHEET

Disposable bed stretcher sheet in TNT

Disposable bed stretcher sheet in TNT. Available in green (25 gr/mq - cm 90x230) and white (28 gr/mq - cm 100x220). Packed in 50 pieces.

# FASTENING SYSTEMS

9



Discover MeBer products on-line  
Shoot the QR code with your tablet  
or smart-phone to land on the  
dedicated page on the website.  
You might be required to install a  
free application to navigate.

Alternatively, go to: <https://www.meber.it/en/products/fixing-systems.aspx>

# FASTENING SYSTEMS FOR STAIR CHAIRS

Art. 975

## ERGOLIFT Fastening system

### Extra Ergolift Stair chair fastening system

Designed to secure the Extra Ergolift Stair Chair to an emergency vehicle. Built in stainless steel, this device is corrosion-resistant and easy-to-clean. Its innovative mono-block configuration ensures a quick and easy locking and unlocking of the chair. This fastening device is compatible with all Extra chairs as well as Zena: 670/BR - 676 - 678 - 679. **Device certified according to the European harmonized safety standard UNI EN 1789.** Size: 58 x 111 x 23 cm (WxHxD)



Art. 960

## EXTRA Fastening system

### Extra stair chair fastening system

Designed to secure the Extra stair chair to an emergency vehicle. Built in stainless steel and thermoplastics, corrosion-resistant and easy-to-clean. This device ensures a quick, easy and efficient fastening. The operator can easily move the stair chair before and after locking, thanks to the innovative mono-block configuration. **Device certified according to the European harmonized safety standard UNI EN 1789.** Size: 23 x 42 x 20 cm (WxHxD)



Art. 977

## KUMA Fastening system

### Kuma stair chair fastening system

Designed to secure the Kuma stair chair to an emergency vehicle. Corrosion-resistant and easy-to-clean. Size: 55 x 120 x 30 cm (WxHxD)



NEW PRODUCT



Art. 618/SUP

Art. 618/INF



Art. 618

### Fastening system for carry chair

Designed to secure all Maya and Quick carry chairs to an emergency vehicle. 2-piece, built in stainless steel. **Device certified according to the European harmonized safety standard UNI EN 1789.**



Art. 988

### Extra Ergolift FX (Art. 675) and Proxima Pro (Art. 683) fastening system

Floor fastening system with integrated unlocking device for Art. 675 Extra Ergolift FX and Art. 683 Proxima Pro. **Device certified according to the European harmonized safety standard UNI EN 1789.**

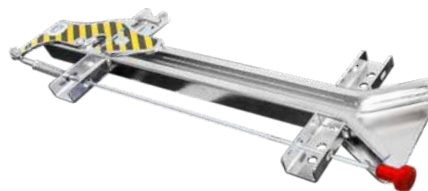

• Also available separately

# FASTENING SYSTEMS FOR **AMBULANCE COTS**

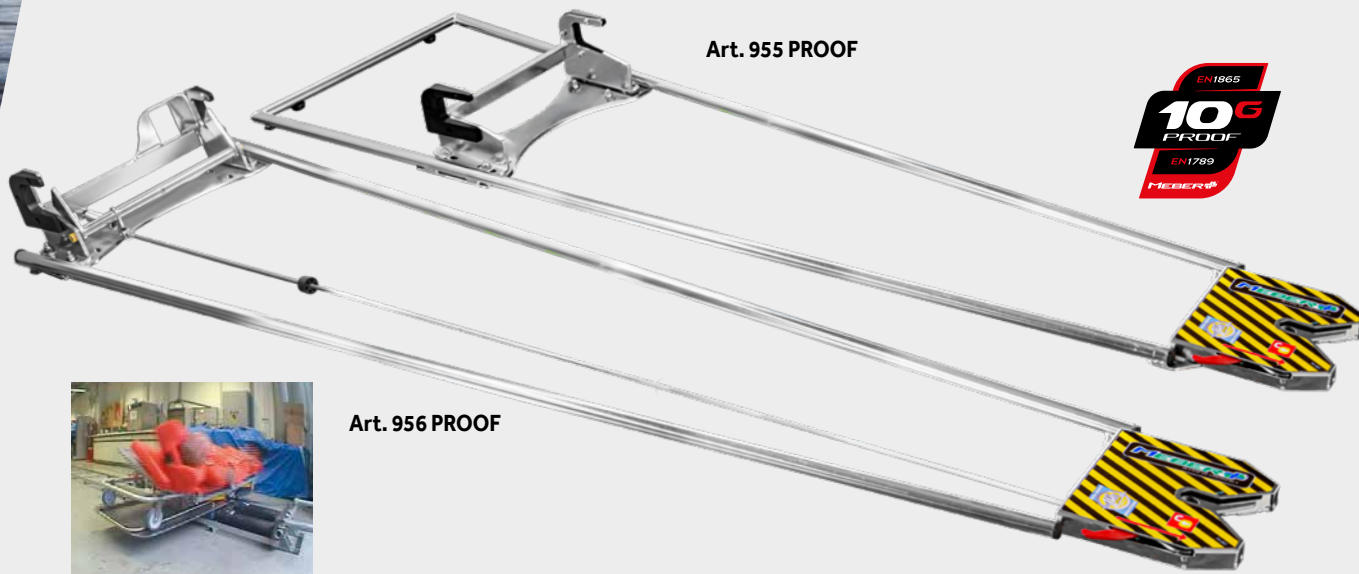

Art. 955 PROOF



Art. 956 PROOF

Art. 956 PROOF

## FASTENING SYSTEM

Art. 955 PROOF

## FASTENING SYSTEM

Designed to ensure maximum stability to the stretcher on the emergency vehicle, these fastening systems are entirely built in stainless steel to offer increased durability and corrosion-resistance. Thanks to their structure, these easily-installed fastening systems ensure perfect containment, in any direction, of the cot or trolley as well as of the patient. The Art. 955 PROOF is fit for all 10G ambulance cots, while the Art. 956 PROOF is fit for the "TITANUS" trolley.

**Device certified according to the European harmonized safety standard UNI EN 1789.**

| Art.      | Front height | Rear height | Width | Length | Weight |
|-----------|--------------|-------------|-------|--------|--------|
| 955 PROOF | 13 cm        | 2,6 cm      | 48 cm | 177 cm | 7,7 kg |
| 956 PROOF | 13 cm        | 2,6 cm      | 42 cm | 175 cm | 8,5 kg |

**Accessories**

Art. 955-001



Front strike plate for 955 - 956 Proof certified fastening systems

Art. 955-002



Rear strike plate for 955 - 966 Proof certified fastening systems

Art. 980

**"MEBER-X" fastening kit for multi-level stretcher, including front lock, lateral lock and rear safety lock.**



**Front lock**  
Length: 54 cm  
Width: 68 cm  
Height: 14 cm



**Lateral lock**  
Length: 75 cm  
Width: 8 cm  
Height: 24 cm



**Rear safety lock**  
Length: 10 cm  
Width: 2 cm  
Height: 5 cm

# FASTENING SYSTEM FOR SCOOP STRETCHERS AND FIXED STRETCHERS

Art. 959

## Wall mount for Variable geometry ERGON scoop stretcher

Wall mount for the ERGON scoop stretcher, made in thermo-plastics. This device ensures a safe and quick installation on any emergency vehicle, vertically. **Device certified according to the European harmonized safety standard UNI EN 1789.**

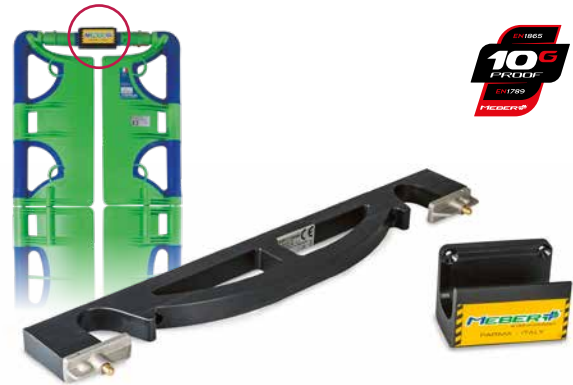

Art. 614

## Horizontal fastening system for scoop stretchers

Aluminium support with safe quick-locking device for wall mount or horizontal storage of a scoop stretcher.

**Device certified according to the European harmonized safety standard UNI EN 1789.**



Art. 963

## Front fastening system for fixed stretchers Art. 1510 PROOF and 1515 PROOF

Max Width 18,5 cm  
Length 9,5 cm  
Height 5 cm



Art. 616

## Certified Vertical fastening system for scoop stretchers



Art. 616/A

## Certified Vertical fastening system for scoop stretchers



Aluminium support with safe quick-locking device for wall mount or vertical storage of a scoop stretcher. The stretcher can be folded and then locked. **Device certified according to the European harmonized safety standard UNI EN 1789.**





# FASTENING SYSTEMS

**Art. 962**  
**EVOX PROOF Fastening system EN 1789**

Fastening system for EVOX art. 7112 Proof, built entirely in stainless steel to offer corrosion-resistance and durability. Thanks to its structure, this device can withstand intense stress up to 10G in all directions, as per UNI EN 1789.



**Art. 964**  
**Front lock for Art. 638 - 640**



**Art. 965**  
**Front lock for ambulance cot**

Blocking device, to be installed on the floor of an ambulance, enabling the locking of an ambulance cot towards its front part. Built in stainless steel.



**Art. 966**  
**Front lock for ambulance trolley**

Blocking device, to be installed on the floor of an ambulance, enabling the locking of an ambulance trolley Art. F7020/4RG towards its front part. Built in stainless steel.



**Art. 950/1**  
**H. 188 mm**



**Art. 950/2**  
**H. 160 mm**



**Art. 950/3**  
**H. 148 mm**



**Art. 950/4**  
**H. 129 mm**

## Rear locking systems for ambulance cots

Built in steel, these systems are installed on the ambulance floors to safely lock an ambulance cot. Available in 4 different heights.



**Art. 1720**  
**Block mm 30 with lever**

Aluminium block, height 30 mm, with security lever.



**Art. 1722**  
**Block mm 30 with lever and little plate**

Aluminium block, height 30 mm, equipped with rotating security lever and a little plate for the wall mount.



**Art. 1725**  
**Block mm 73 with lever and little plate**

Aluminium block, height 73 mm, equipped with rotating security lever and a little plate for wall mount.



**Art. 970**  
**Complete din blocking device**

Device for the locking on stainless steel supports of the rigid stretchers (Art. 1510-1515), DIN sizes. Set with 4 pieces.

# FASTENING SYSTEMS

## COMPARATION CHART FOR FASTENING SYSTEMS

|   | Art.             | Suitable for  |   | Art.        | Suitable for  |
|---|------------------|---|---|-------------|---|
|    | <b>614</b>       | Maxima [630, 631] - 6200  |    | <b>975</b>  | Extra Ergolift [671] -<br>Extra [670, 670/BR] -<br>Extra Lite [676, 678] -<br>Extra Lite Zena [679] |
|    | <b>616</b>       | Maxima [630, 631]   |    | <b>960</b>  | Extra [670, 670/BR] -<br>Extra Lite [676, 678] -<br>Extra Lite Zena [679]                           |
|    | <b>616/A</b>     | Maxima [630, 631]   |    | <b>962</b>  | Evox Proof [7112]   |
|    | <b>618</b>       | Maya [650, 653] -<br>Quick [658, 659]   |    | <b>963</b>  | 1510 Proof - 1515 Proof   |
|   | <b>988</b>       | Ergolift fx [675] -<br>Proxima Pro [683]  |   | <b>964</b>  | 638 - 640   |
|  | <b>950/1</b>     | Winner [910, 914]   |  | <b>965</b>  | Frog [7210] - Winner [910, 914] -<br>Gecko [7122/V, 7122/AZ]  |
|  | <b>950/2</b>     | Winner [910, 914]   |  | <b>966</b>  | Titanus [F7020/4RG]   |
|  | <b>950/3</b>     | Frog [7210] -<br>Winner [910, 914] -<br>Gecko [7122/V, 7122/AZ]   |  | <b>970</b>  | 1510 Proof - 1515 Proof   |
|  | <b>950/4</b>     | Titanus [F7020] - 638 - 640   |  | <b>977</b>  | Kuma [668]  |
|  | <b>955 PROOF</b> | Mercury [7070, 7072] - Mercury Lite [7080 /4rg, 7082 /4rg] - Mercury 5 [7075/4RG, 7077/4RG] - Mercury 5 Lite [7095/4RG, 7097/4RG] - Mercury EL [7092 Proof, 7094 Proof] - Frog [7210 Proof] - Frog Plus [7240 Proof] - Frog Lite [7260 proof] |  | <b>1720</b> | Galaxy [9010, 9012, 9016] -<br>Duck [9022, 9024]  |
|  | <b>956 PROOF</b> | Titanus [7060 /4rg, 7062 /4rg]  |  | <b>1722</b> | Galaxy [9010, 9012, 9016] -<br>Duck [9022, 9024]  |
|  | <b>959</b>       | Ergon [16150/G, 16150/V] -<br>Ergon Junior [16160/G, 16160/V]   |  | <b>1725</b> | Multi purpose fixing system   |
|   |                  |   |  | <b>980</b>  | Meber-X [7300]  |

# RESTRAINT SYSTEMS

# 10



Discover MeBer products on-line  
Shoot the QR code with your tablet  
or smart-phone to land on the  
dedicated page on the website.  
You might be required to install a  
free application to navigate.

Alternatively, go to: <https://www.meber.it/en/products/restraint-systems.aspx>

# SPIDER STRAPS FOR SPINAL BOARDS AND ERGON



Art. 9156

## X-FIX

Straps restraint system with carabiners

Standard restraint straps with carabiners: innovative system designed to ease rescue operations, ensuring high comfort and spinal stability.



Art. 690

## SPIDER

Spinal board straps

This strap system ensures a precise patient restraint. Thanks to the transversally sliding VELCRO® straps, this device can fit any spinal board and any patient.



Art. 692

## SPIDER BABY

Pediatric spinal board straps

This strap system ensures a precise patient restraint on a "DUCK" pediatric board. Thanks to the transversally sliding VELCRO® straps, this device can fit any spinal board and any patient.

# STAIR CHAIRS AND AMBULANCE COTS BELTS AND STRAPS



Art. 610

Black Thoracic-abdominal belt with 4-buckles system for padded chair.



Art. 612/N-2/MEB

Black/orange or full black adjustable chest belt with 4-buckles system and MEBER logo for ambulance cots and stair chairs



Art. 612/AN-2/MEB

# BELTS



**Art. 605/C** 1 piece orange belt mm 50, plastic buckle and MEBER logo for mattresses proof, length 115 cm



**Art. 605/Nmeb** 1 piece black belt with plastic buckle and MEBER logo, 50 mm



**Art. 605/MEB** 1 piece orange belt with plastic buckle and MEBER logo, 50 mm



**Art. 606-A/MEB** 1 piece orange belt with metal buckle and MEBER logo (Length 190 cm)



**Art. 606-N/MEB** 1 piece black belt with metal buckle and MEBER logo (length 190 cm)



**Art. 607/A** 2-pieces orange belt with plastic buckle for stretchers, 50 mm



**Art. 607/A-MEB** 2-pieces orange belt with plastic buckle and MEBER logo, 50 mm



**Art. 607/B** Blue belt, 2-pieces with plastic buckle for stretchers, 50 mm



**Art. 608-A/MEB** 2-pieces orange belt with metal buckle and MEBER logo (Length 155 cm)



**Art. 608/N** 2-pieces black belt with metal buckle (Length 155 cm)



**Art. 608-N/MEB** 2-pieces black belt with metal buckle and MEBER logo (Length 155 cm)



**Art. 572** 2-pieces blue belt with quick-release metal buckle and carabiners, MEBER logo



**Art. 568** 2-pieces orange belt with plastic buckle and MEBER logo, 40 mm

# BELT SETS WITH CARRYING POUCH



**Art. 566** Black pouch with 3 belts Art. 607/Nmeb, 2-pieces black belt with orange MEBER logo for EXTRA stair chairs



**Art. 574** Blue pouch with 3 belts Art. 572, 2-pieces blue belt with quick-release metal buckle and carabiners, MEBER logo



**Art. 584** Black pouch with 3 belts art. 568 for ERGON stretchers



**Art. 604/MEB** Orange pouch with 2 belts 605/MEB



**Art. F602/B** Blue pouch with 3 blue belts with plastic buckle



**Art. 602/MEB** Orange pouch with 3 belts 605/MEB



**Art. 590/N** Black nylon pouch with 3 black belts Art.605/Nmeb for stair chairs, 1 piece belts with plastic buckle



**Art. 603/MEB** Nylon pouch with 3 belts Art. 607/Ameb



**Art. 603** Nylon pouch with 3 belts Art. 607/A



**Art. 600** Pouch with 3 belts Art. 606



**Art. 600/N** Pouch with 3 belts Art. 606-N/MEB



**Art. 601** Pouch with 3 belts Art. 608



**Art. 601/N** Pouch with 3 belts Art. 608-N/MEB

**NEW PRODUCT**

**NEW PRODUCT**

# AMBULANCE COTS **SUPPORTS**

# 11



Discover MeBer products on-line. Shoot the QR code with your tablet or smart-phone to land on the dedicated page on the website. You might be required to install a free application to navigate.

Alternatively, go to:  
<https://www.meber.it/en/products/stretcher-supports.aspx>

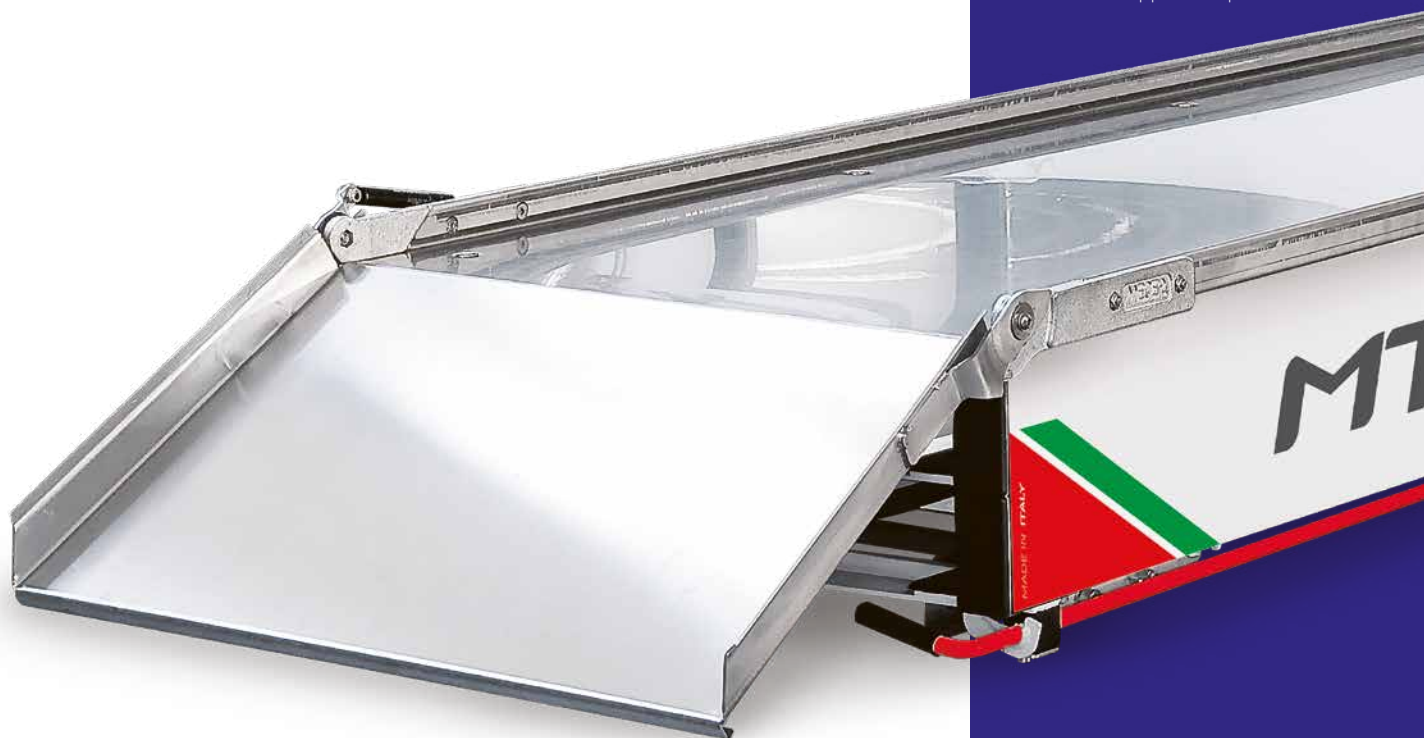

## AMBULANCE COTS SUPPORTS

# MTX

SINGLE SPACE SUPPORT WITH LATERAL MOVEMENT



Art. 19152-130

## MTX-AR-130

Reduced height ambulance cot support with lateral movement (no space underneath), with 130 mm ramp

Art. 19130-955

## MTX-955

Single-space cot support with lateral movement, 180 mm ramp and Art. 955 fastening system – **Certified EN1789**

Art. 19130-956

## MTX-956

Single-space cot support with lateral movement, 180 mm ramp and Art. 956 fastening system – **Certified EN1789**

Art. 19130

## MTX

Single-space cot support with lateral movement, 180 mm ramp – **Certified EN1789**

# MTX-2

DOUBLE-SPACE AMBULANCE COT SUPPORT WITH LATERAL MOVEMENT



Double-space ambulance cot support with lateral movement and 350 mm ramp. The underneath space may house both a scoop stretcher and a spinal board. Fastening systems 955 and 956 can be integrated.



Art. 19140

## MTX-2

Double-space ambulance cot support with lateral movement and 350 mm ramp – **Certified EN1789**

Art. 19140-955

## MTX-2-955

Double space ambulance cot support with lateral movement and 350 mm ramp, fastening system Art. 955 – **Certified EN1789**

Art. 19140-956

## MTX-2-956

Double space ambulance cot support with lateral movement and 350 mm ramp, fastening system Art. 956 – **Certified EN1789**

| Art.      | Width   | Total height | Plate height | Length   | Weight  | Loading capacity | Side sliding |
|-----------|---------|--------------|--------------|----------|---------|------------------|--------------|
| 19130     | 60,5 cm | 20 cm        | 17 cm        | 214,5 cm | 58 kg   | 400 kg           | 30 cm        |
| 19130-955 | 60,5 cm | 30 cm        | 17 cm        | 214,5 cm | 66,5 kg | 400 kg           | 30 cm        |
| 19130-956 | 60,5 cm | 30 cm        | 17 cm        | 214,5 cm | 66,5 kg | 400 kg           | 30 cm        |
| 19152-130 | 60,5 cm | 14,3 cm      | 11,3 cm      | 208      | 42 kg   | 400 kg           | 30 cm        |
| 19140     | 63 cm   | 28 cm        | 25 cm        | 229 cm   | 76 kg   | 400 kg           | 30 cm        |
| 19140-955 | 63 cm   | 38 cm        | 25 cm        | 229 cm   | 84,5 kg | 400 kg           | 30 cm        |
| 19140-956 | 63 cm   | 38 cm        | 25 cm        | 229 cm   | 84,5 kg | 400 kg           | 30 cm        |



# MX | MX-2

SINGLE-SPACE AND DOUBLE-SPACE FIXED SUPPORT FOR AMBULANCE COTS

Art. 19136



Art. 19146



**Art. 19136**  
**MX**

Single space fixed support with 180 mm ramp - **Certified EN1789**

**Art. 19136-955**  
**MX-955**

Single space fixed support with 180 mm ramp and fastening system Art. 955 - **Certified EN1789**

**Art. 19136-956**  
**MX-956**

Single space fixed support with 180 mm ramp and fastening system Art. 956 - **Certified EN1789**

**Art. 19146**  
**MX-2**

Double-space fixed support with 350 mm ramp - **Certified EN1789**

**Art. 19146-955**  
**MX-2-955**

Double-space fixed support with 350 mm ramp and fastening system Art. 955 - **Certified EN1789**

**Art. 19146-956**  
**MX-2-956**

Double-space fixed support with 350 mm ramp and fastening system Art. 956 - **Certified EN1789**

| Art.         | Width   | Total height | Plate height | Length   | Weight  | Loading capacity |
|--------------|---------|--------------|--------------|----------|---------|------------------|
| 19136        | 60,5 cm | 15,5 cm      | 12,5 cm      | 208,5 cm | 41,5 kg | 400 kg           |
| 19136-955    | 60,5 cm | 25,5 cm      | 12,5 cm      | 208,5 cm | 50 kg   | 400 kg           |
| 19136-956    | 60,5 cm | 25,5 cm      | 12,5 cm      | 208,5 cm | 50 kg   | 400 kg           |
| 19146        | 63 cm   | 23,5 cm      | 20,5 cm      | 223 cm   | 59,7 kg | 400 kg           |
| 19146-955    | 63 cm   | 33,5 cm      | 20,5 cm      | 223 cm   | 68,2 kg | 400 kg           |
| 19146-956    | 63 cm   | 33,5 cm      | 20,5 cm      | 223 cm   | 68,2 kg | 400 kg           |
| 19156-130    | 62 cm   | 24 cm        | 21 cm        | 204,7 cm | 67 kg   | 400 kg           |
| 19156-130-AL | 62 cm   | 24 cm        | 21 cm        | 204,7 cm | 47 kg   | 400 kg           |
| 19162        | 77,5 cm | 27 cm        | 25 cm        | 201 cm   | 75 kg   | 400 kg           |

# MTX-2R

REDUCED HEIGHT DOUBLE-SPACE COT SUPPORT WITH LATERAL MOVEMENT



Art. 19156-130

## MTX-2R

Reduced height double space-cot support with 130 mm ramp

Reduced height double space cot support with 130 mm ramp. The space underneath may house both a scoop stretcher and a spinal board, despite the reduced height (-40 mm) compared to the MTX-2. **Certified EN1789**. Max lateral movement 30 cm.

Art. 19156-130-AL

## MTX-2R AL

Reduced height double-space cot support in aluminium with 130 mm ramp

Sharing the same features of the MTX-2R, this support presents an aluminium structure, reducing its weight of approximately 20 kg. **Certified EN1789**. Max lateral movement 30 cm.

# MTX-2-X



DOUBLE SPACE COT SUPPORT WITH LATERAL MOVEMENT FOR MEBER-X STRETCHER

Art. 19162

## MTX-2-X

Double-space cot support with lateral movement with special MEBER-X system with holes, no ramp



# HERCULES

POWERED DOUBLE SPACE COT SUPPORT WITH LATERAL MOVEMENT



Bariatric

Art. 19170

## MTX-2RH-AL

Double-space ambulance space cot support in aluminium, with reduced height, lateral movement, HERCULES system (stainless steel), 955 Proof and 180 mm ramp with roller

The HERCULES is the new ambulance cot support with motor-powered loading and unloading.

The integrated position detectors and small pushbutton ensure a safe and easy use of this support. The loading takes place by means of a quick-release buckle system with belt, actioned by an integrated coaxial motor. No outer volume. Equipped with a double-safety system, to ensure total safety during loading and unloading). Can be installed on MTX-2R and MTX-2R-AL. 180 mm ramp. The underneath space may house both a scoop stretcher and a spinal board, despite the reduced height (~40 cm) compared to the MTX-2.

**Certified EN1789.**

**30 cm lateral movement.**

| Art.  | Length   | Width   | Plate Height | Total Height | Weight | Load Capacity | Lateral movement |
|-------|----------|---------|--------------|--------------|--------|---------------|------------------|
| 19170 | 216,5 cm | 57,8 cm | 21 cm        | 34 cm        | 65 kg  | 400 kg        | 30 cm (15 + 15)  |



Art. 19170 + 955 PROOF +  
7270 + 12084 + 12170  
+ 12172 + 7013/N

**High efficiency  
motor**

For an efficient operator  
support during the  
loading of bariatric  
patients.

Double-space  
Ergon/spinal board/  
scoop stretcher



Pushbutton

# ACCESSORIES

**MTX** AND **MX** AMBULANCE COT SUPPORTS



**Art. 19110**

**Stainless steel plate mm 1917 x 572 with connections for MTX, MTX-2 and MX.**



**Art. 19112**

**100 mm ramp with support connections.**



**Art. 19114**

**130 mm ramp with support connections.**

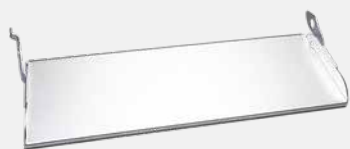

**Art. 19116**

**180 mm with support connections.**

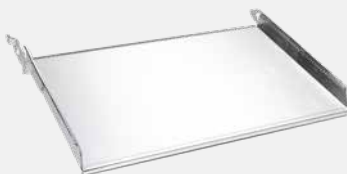

**Art. 19118**

**350 mm ramp with connections and gas spring.**



**NEW PRODUCT**

**Art. 787L**

**Gas spring for support's side.**

## AMBULANCE COT SUPPORTS WITH LATERAL MOVEMENT



**NEW PRODUCT**

**Art. 19115**

**180 mm ramp with lateral sides and roller for lateral movement**



**NEW PRODUCT**

**Art. 19123**

**130 mm ramp with lateral sides and roller for lateral movement**

| Art.  | Length | Width   | Plate Height | Weight  |
|-------|--------|---------|--------------|---------|
| 19110 | 194 cm | 59 cm   | 2,5 cm       | 16,3 kg |
| 19112 | 10 cm  | 62 cm   | 1,6 cm       | 1,4 kg  |
| 19114 | 13 cm  | 61 cm   | 1,7 cm       | 1,7 kg  |
| 19115 | 18 cm  | 62,5 cm | 1,7 cm       | 2,8 kg  |
| 19116 | 18 cm  | 63 cm   | 1,7 cm       | 2,3 kg  |
| 19118 | 35 cm  | 62 cm   | 5,4 cm       | 4,3 kg  |
| 19123 | 13 cm  | 60,5 cm | 1,7 cm       | 2,3 kg  |

# VETERINARY



**Art. 6100**

### Foldable stretcher (long) for veterinary use

Foldable stretcher with foot supports and handles, built in aluminium, with tearproof, water-proof PVC canvas. Ideal for transfers. Easily stored. Two available sizes

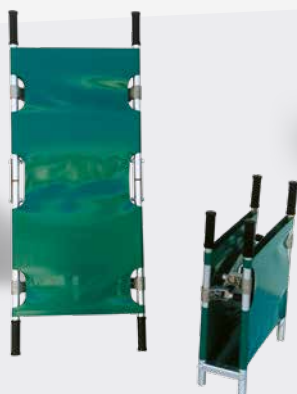

**Art. 6150**

### Foldable stretcher (short) for veterinary use

Foldable stretcher with foot supports and handles, built in aluminium, with tearproof, water-proof PVC canvas. Ideal for transfers. Easily stored. Two available sizes



**Art. 6200/V**

### Scoop stretcher for veterinary use

Entirely built in aluminium, this stretcher can be detached, ensuring a safe loading of the patient, reducing movement. Equipped with two quick-release buckle straps

| Art.   | Length | Canvas length | Width | Height | Folded height | Depth | Weight |
|--------|--------|---------------|-------|--------|---------------|-------|--------|
| 6100   | 167 cm | 140 cm        | 50 cm | 13 cm  | 83 cm         | 13 cm | 5,5 kg |
| 6150   | 127 cm | 100 cm        | 50 cm | 13 cm  | 63 cm         | 13 cm | 5,5 kg |
| 6200/V | 130 cm | -             | 42 cm | 7 cm   | -             | -     | 7,8 kg |
| 6300/B | 100 cm | -             | 65 cm | -      | -             | -     | 3,5 kg |



**Art. 6300/B**

### Vacuum mattress for veterinary use

This article ensures a precise immobilization of the patient, thus easing transfers. Built in PVC, this article does not absorb moisture and is easy-to-clean. Equipped with 4 handles for transport



**Art. 896/DF**

### Suction pump

ABS suction pump for vacuum mattress. Can be used to inflate

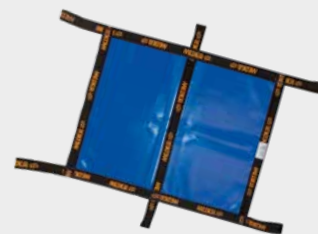

**Art. 6315**

### 6-handles transfer sheet

Animal transfer sheet, made in water-proof, fireproof, tear-proof nylon. **Size 75 x 100 cm.**







# GENERAL SALE CONDITIONS

## ORDERS

---

For a faster and more accurate service please send orders by fax, letter or e-mail and make sure that all your data, including V.A.T. Registration Number, are included. Please also specify code and description of the articles.

## PRICE

---

Prices are subject to variation at any time without previous notice. Prices are ex works Fontanini – Italy and do not include V.A.T.

## DELIVERY

---

Goods travel at customer's risk.

## PACKING

---

Standard packing is supplied free of charge.

## WARRANTY

---

The articles are guaranteed for 12 months. The warranty covers damages and/or breakages by defects in the materials used, defects in the working or imperfect assembly, furthermore it expires if the products are not used in the correct way, if they are altered and/or repaired by personnel not authorized by Me.Ber.

## PAYMENT

---

Payments must always be in advance or on delivery. Other terms of payment may be arranged with our sales department or with our agents in your area. In the event of outstanding payments, the current bank interest plus a fixed amount of 26,00 € will be added to the due amount.

## CLAIMS

---

Claims are accepted within 8 days from receipt of the goods.

## RETURNS

---

Returns will be accepted only upon authorization of our sales department and free of transport charges.

## CONTROVERSIES

---

In case of any controversy, Parma is the competent court.

Texts, articles, technical data and pictures are subject to variation at anytime without notice.



- Stretchers
- Ambulance Cots and Trolleys
- Carry and Stair Chairs
- Accessories
- Immobilization
- Diagnostics
- Resuscitation
- First Aid
- Fastening systems
- Restraint systems
- Supports
- Veterinary

# MEBERIT<sup>®</sup>

Me.Ber. s.r.l. Unipersonale

Strada Langhirano, 270  
43124 Fontanini (Parma) Italy  
Ph. +39 0521 648770  
Fax +39 0521 648780  
e-mail: [info@meber.it](mailto:info@meber.it)

